



OWNER'S MANUAL



YZFR1W(C)

LIT-11626-20-53

4C8-28199-10

EAU10041

 **WARNING**

The engine exhaust from this product contains chemicals known to the State of California to cause cancer, birth defects or other reproductive harm.

YAMAHA

LIT-CALIF-65-01

Congratulations on your purchase of the Yamaha YZFR1W(C). This model is the result of Yamaha's vast experience in the production of fine sporting, touring, and pacesetting racing machines. It represents the high degree of craftsmanship and reliability that have made Yamaha a leader in these fields.



This manual will give you an understanding of the operation, inspection, and basic maintenance of this motorcycle. If you have any questions concerning the operation or maintenance of your motorcycle, please consult a Yamaha dealer.

The design and manufacture of this Yamaha motorcycle fully comply with the emissions standards for clean air applicable at the date of manufacture. Yamaha has met these standards without reducing the performance or economy of operation of the motorcycle. To maintain these high standards, it is important that you and your Yamaha dealer pay close attention to the recommended maintenance schedules and operating instructions contained within this manual.

IMPORTANT MANUAL INFORMATION

EAU10131

Particularly important information is distinguished in this manual by the following notations:

	The Safety Alert Symbol means ATTENTION! BECOME ALERT! YOUR SAFETY IS INVOLVED!
	Failure to follow WARNING instructions could result in severe injury or death to the motorcycle operator, a bystander or a person inspecting or repairing the motorcycle.
CAUTION:	A CAUTION indicates special precautions that must be taken to avoid damage to the motorcycle.
NOTE:	A NOTE provides key information to make procedures easier or clearer.

NOTE:

- This manual should be considered a permanent part of this motorcycle and should remain with it even if the motorcycle is subsequently sold.
- Yamaha continually seeks advancements in product design and quality. Therefore, while this manual contains the most current product information available at the time of printing, there may be minor discrepancies between your motorcycle and this manual. If you have any questions concerning this manual, please consult your Yamaha dealer.

EWA10010

WARNING

PLEASE READ THIS MANUAL AND THE “YOU AND YOUR MOTORCYCLE: RIDING TIPS” BOOKLET CAREFULLY AND COMPLETELY BEFORE OPERATING THIS MOTORCYCLE. DO NOT ATTEMPT TO OPERATE THIS MOTORCYCLE UNTIL YOU HAVE ATTAINED ADEQUATE KNOWLEDGE OF ITS CONTROLS AND OPERATING FEATURES

IMPORTANT MANUAL INFORMATION

AND UNTIL YOU HAVE BEEN TRAINED IN SAFE AND PROPER RIDING TECHNIQUES. REGULAR INSPECTIONS AND CAREFUL MAINTENANCE, ALONG WITH GOOD RIDING SKILLS, WILL ENSURE THAT YOU SAFELY ENJOY THE CAPABILITIES AND THE RELIABILITY OF THIS MOTORCYCLE.

*Product and specifications are subject to change without notice.

IMPORTANT MANUAL INFORMATION

EAU10192

AFFIX DEALER
LABEL HERE

**YZFR1W(C)
OWNER'S MANUAL**
©2006 by Yamaha Motor Corporation, U.S.A.
1st edition, September 2006
All rights reserved.
Any reprinting or unauthorized use
without the written permission of
Yamaha Motor Corporation, U.S.A.
is expressly prohibited.
Printed in Japan.
P/N LIT-11626-20-53

TABLE OF CONTENTS

SAFETY INFORMATION	1-1	PRE-OPERATION CHECKS	4-1	Accessories and	
Location of important labels	1-5	Pre-operation check list	4-2	replacement parts	6-24
DESCRIPTION	2-1	OPERATION AND IMPORTANT		Adjusting the clutch lever	
Left view	2-1	RIDING POINTS	5-1	free play	6-25
Right view	2-2	Starting the engine	5-1	Adjusting the rear brake	
Controls and instruments	2-3	Shifting	5-2	light switch	6-26
INSTRUMENT AND CONTROL		Engine break-in	5-3	Checking the front and	
FUNCTIONS	3-1	Parking	5-4	rear brake pads	6-26
Main switch/steering lock	3-1	PERIODIC MAINTENANCE AND		Checking the brake fluid level	6-27
Indicator and warning lights	3-2	MINOR REPAIR	6-1	Changing the brake fluid	6-28
Multi-function meter unit	3-5	PERIODIC MAINTENANCE	6-1	Drive chain slack	6-28
Handlebar switches	3-11	Owner's tool kit	6-1	Cleaning and lubricating	
Clutch lever	3-12	Periodic maintenance chart for		the drive chain	6-29
Shift pedal	3-12	the emission control system	6-3	Checking and lubricating	
Brake lever	3-12	General maintenance and		the throttle grip and cable	6-30
Brake pedal	3-13	lubrication chart	6-4	Checking and lubricating	
Fuel tank cap	3-13	Removing and installing cowlings		the brake and clutch levers	6-31
Fuel	3-14	and panels	6-9	Checking and lubricating	
Catalytic converter	3-15	Checking the spark plugs	6-12	the shift pedal	6-31
Seats	3-15	Canister (for California only)	6-13	Checking and lubricating	
Helmet holders	3-16	Engine oil and oil filter cartridge ...	6-13	the sidestand	6-32
Adjusting the front fork	3-17	Coolant	6-16	Lubricating the swingarm pivots ...	6-32
Adjusting the shock absorber		Replacing the air filter element	6-19	Checking the front fork	6-32
assembly	3-19	Checking the throttle cable		Checking the steering	6-33
Luggage strap holders	3-21	free play	6-21	Checking the wheel bearings	6-34
EXUP system	3-21	Valve clearance	6-21	Battery	6-34
Sidestand	3-22	Tires	6-22	Replacing the fuses	6-35
Ignition circuit cut-off system	3-22	Cast wheels	6-24	Replacing a headlight bulb	6-37
				Tail/brake light	6-40

TABLE OF CONTENTS

Replacing a turn signal	
light bulb	6-40
Replacing the license plate	
light bulb	6-41
Replacing an auxiliary light bulb ...	6-41
Supporting the motorcycle	6-42
Front wheel	6-43
Rear wheel	6-45
Troubleshooting	6-46
Troubleshooting charts	6-47

MOTORCYCLE CARE AND

STORAGE	7-1
Matte color caution	7-1
Care	7-1
Storage	7-4

SPECIFICATIONS

8-1

CONSUMER INFORMATION

9-1

Identification numbers	9-1
Reporting safety defects	9-3
Motorcycle noise regulation	9-4
Maintenance record	9-5
YAMAHA MOTOR CORPORATION, U.S.A. STREET AND ENDURO MOTORCYCLE LIMITED WARRANTY	9-7
YAMAHA EXTENDED SERVICE (Y.E.S.)	9-9

EAU10281

MOTORCYCLES ARE SINGLE TRACK VEHICLES. THEIR SAFE USE AND OPERATION ARE DEPENDENT UPON THE USE OF PROPER RIDING TECHNIQUES AS WELL AS THE EXPERTISE OF THE OPERATOR. EVERY OPERATOR SHOULD KNOW THE FOLLOWING REQUIREMENTS BEFORE RIDING THIS MOTORCYCLE.

HE OR SHE SHOULD:

- OBTAIN THOROUGH INSTRUCTIONS FROM A COMPETENT SOURCE ON ALL ASPECTS OF MOTORCYCLE OPERATION.
- OBSERVE THE WARNINGS AND MAINTENANCE REQUIREMENTS IN THE OWNER'S MANUAL.
- OBTAIN QUALIFIED TRAINING IN SAFE AND PROPER RIDING TECHNIQUES.
- OBTAIN PROFESSIONAL TECHNICAL SERVICE AS INDICATED BY THE OWNER'S MANUAL

AND/OR WHEN MADE NECESSARY BY MECHANICAL CONDITIONS.

Safe riding

- Always make pre-operation checks. Careful checks may help prevent an accident.
- This motorcycle is designed to carry the operator and a passenger.
- The failure of motorists to detect and recognize motorcycles in traffic is the predominating cause of automobile/motorcycle accidents. Many accidents have been caused by an automobile driver who did not see the motorcycle. Making yourself conspicuous appears to be very effective in reducing the chance of this type of accident.

Therefore:

- Wear a brightly colored jacket.
- Use extra caution when you are approaching and passing through intersections, since intersections are the most likely places for motorcycle accidents to occur.

- Ride where other motorists can see you. Avoid riding in another motorist's blind spot.
- Many accidents involve inexperienced operators. In fact, many operators who have been involved in accidents do not even have a current motorcycle license.
- Make sure that you are qualified and that you only lend your motorcycle to other qualified operators.
- Know your skills and limits. Staying within your limits may help you to avoid an accident.
- We recommend that you practice riding your motorcycle where there is no traffic until you have become thoroughly familiar with the motorcycle and all of its controls.
- Many accidents have been caused by error of the motorcycle operator. A typical error made by the operator is veering wide on a turn

SAFETY INFORMATION

1

due to EXCESSIVE SPEED or undercornering (insufficient lean angle for the speed).

- Always obey the speed limit and never travel faster than warranted by road and traffic conditions.
- Always signal before turning or changing lanes. Make sure that other motorists can see you.
- The posture of the operator and passenger is important for proper control.
 - The operator should keep both hands on the handlebar and both feet on the operator footrests during operation to maintain control of the motorcycle.
 - The passenger should always hold onto the operator, the seat strap or grab bar, if equipped, with both hands and keep both feet on the passenger footrests.
 - Never carry a passenger unless he or she can firmly place both feet on the passenger footrests.
- Never ride under the influence of alcohol or other drugs.

- This motorcycle is designed for on-road use only. It is not suitable for off-road use.

Protective apparel

The majority of fatalities from motorcycle accidents are the result of head injuries. The use of a safety helmet is the single most critical factor in the prevention or reduction of head injuries.

- Always wear an approved helmet.
- Wear a face shield or goggles. Wind in your unprotected eyes could contribute to an impairment of vision that could delay seeing a hazard.
- The use of a jacket, heavy boots, trousers, gloves, etc., is effective in preventing or reducing abrasions or lacerations.
- Never wear loose-fitting clothes, otherwise they could catch on the control levers, footrests, or wheels and cause injury or an accident.
- Never touch the engine or exhaust system during or after operation. They become very hot and can

cause burns. Always wear protective clothing that covers your legs, ankles, and feet.

- A passenger should also observe the above precautions.

Modifications

Modifications made to this motorcycle not approved by Yamaha, or the removal of original equipment, may render the motorcycle unsafe for use and may cause severe personal injury. Modifications may also make your motorcycle illegal to use.

Loading and accessories

Adding accessories or cargo to your motorcycle can adversely affect stability and handling if the weight distribution of the motorcycle is changed. To avoid the possibility of an accident, use extreme caution when adding cargo or accessories to your motorcycle. Use extra care when riding a motorcycle that has added cargo or accessories. Here are some general guidelines to follow if loading cargo or adding accessories to your motorcycle:

Loading

The total weight of the operator, passenger, accessories and cargo must not exceed the maximum load limit.

Maximum load:
195 kg (430 lb)

When loading within this weight limit, keep the following in mind:

- Cargo and accessory weight should be kept as low and close to the motorcycle as possible. Make sure to distribute the weight as evenly as possible on both sides of the motorcycle to minimize imbalance or instability.
- Shifting weights can create a sudden imbalance. Make sure that accessories and cargo are securely attached to the motorcycle before riding. Check accessory mounts and cargo restraints frequently.
- Never attach any large or heavy items to the handlebar, front fork, or front fender. These items, including such cargo as sleeping

bags, duffel bags, or tents, can create unstable handling or a slow steering response.

Accessories

Genuine Yamaha accessories have been specifically designed for use on this motorcycle. Since Yamaha cannot test all other accessories that may be available, you must personally be responsible for the proper selection, installation and use of non-Yamaha accessories. Use extreme caution when selecting and installing any accessories.

Keep the following guidelines in mind, as well as those provided under “Loading” when mounting accessories.

- Never install accessories or carry cargo that would impair the performance of your motorcycle. Carefully inspect the accessory before using it to make sure that it does not in any way reduce ground clearance or cornering clearance,

limit suspension travel, steering travel or control operation, or obscure lights or reflectors.

- Accessories fitted to the handlebar or the front fork area can create instability due to improper weight distribution or aerodynamic changes. If accessories are added to the handlebar or front fork area, they must be as lightweight as possible and should be kept to a minimum.
- Bulky or large accessories may seriously affect the stability of the motorcycle due to aerodynamic effects. Wind may attempt to lift the motorcycle, or the motorcycle may become unstable in cross winds. These accessories may also cause instability when passing or being passed by large vehicles.
- Certain accessories can displace the operator from his or her normal riding position. This improper position limits the freedom of movement of the opera-

SAFETY INFORMATION

tor and may limit control ability, therefore, such accessories are not recommended.

- Use caution when adding electrical accessories. If electrical accessories exceed the capacity of the motorcycle's electrical system, an electric failure could result, which could cause a dangerous loss of lights or engine power.

Gasoline and exhaust gas

- **GASOLINE IS HIGHLY FLAMMABLE:**
 - Always turn the engine off when refueling.
 - Take care not to spill any gasoline on the engine or exhaust system when refueling.
 - Never refuel while smoking or in the vicinity of an open flame.
- Never start the engine or let it run for any length of time in a closed area. The exhaust fumes are poisonous and may cause loss of consciousness and death within a short time. Always operate your motorcycle in an area that has adequate ventilation.

- Always turn the engine off before leaving the motorcycle unattended and remove the key from the main switch. When parking the motorcycle, note the following:
 - The engine and exhaust system may be hot, therefore, park the motorcycle in a place where pedestrians or children are not likely to touch these hot areas.
 - Do not park the motorcycle on a slope or soft ground, otherwise it may fall over.
 - Do not park the motorcycle near a flammable source, (e.g., a kerosene heater, or near an open flame), otherwise it could catch fire.
- When transporting the motorcycle in another vehicle, make sure that it is kept upright. If the motorcycle should lean over, gasoline may leak out of the fuel tank.
- If you should swallow any gasoline, inhale a lot of gasoline vapor, or allow gasoline to get into your eyes, see your doctor immediately. If any gasoline spills on your skin

or clothing, immediately wash the affected area with soap and water and change your clothes.

Location of important labels

Please read the following important labels carefully before operating this vehicle.

1

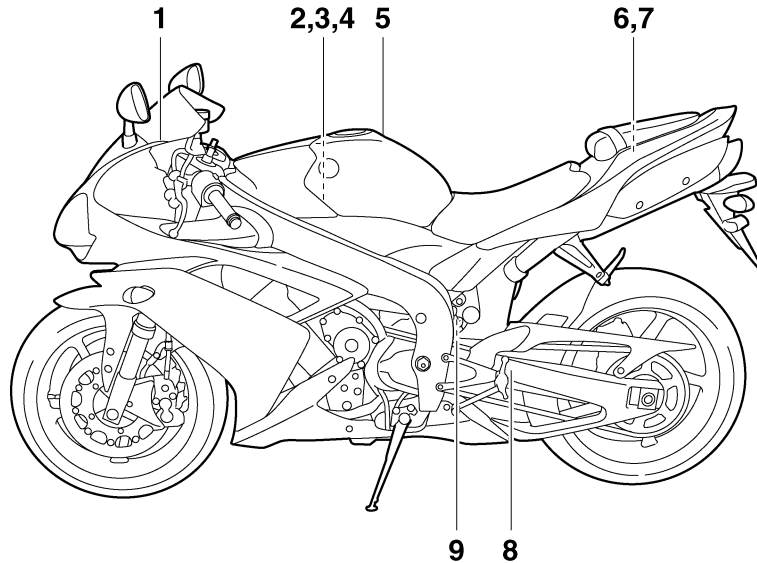

SAFETY INFORMATION

1

1

CAUTION

- Cleaning with alkaline or acid cleaner, gasoline or solvent will damage windshield.
- Use neutral detergent.

5JW-00

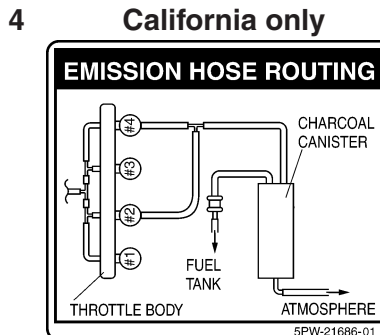
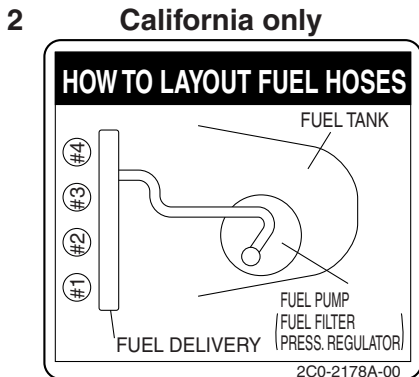
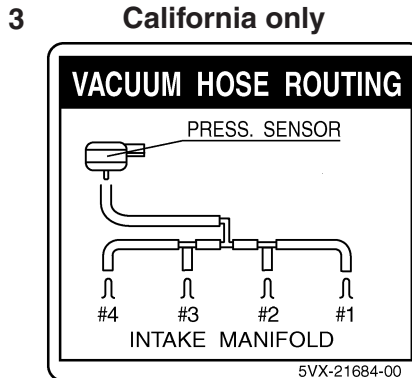

5

⚠ WARNING

- BEFORE YOU OPERATE THIS VEHICLE, READ THE OWNER'S MANUAL AND ALL LABELS.
- ALWAYS WEAR AN APPROVED MOTORCYCLE HELMET, eye protection, and protective clothing.

PREMIUM UNLEADED GASOLINE ONLY
91 Min. Pump Octane (R+M)/2

4C8-2118K-00

6

LOAD LIMIT

3 kg {7 lbs}

3TB-24877-A0

7

⚠ WARNING

Improper loading can cause loss of control.
Read owner's manual for proper loading.

3JJ-28446-A1

8

TIRE INFORMATION

Cold tire normal pressure should be set as follows.

- Up to 90 kg (198 lbs) load

FRONT : 250 kPa, {2.50 kgf/cm²}, 36psi
REAR : 290 kPa, {2.90 kgf/cm²}, 42psi

- 90 kg (198 lbs) ~ maximum load

FRONT : 250 kPa, {2.50 kgf/cm²}, 36psi
REAR : 290 kPa, {2.90 kgf/cm²}, 42psi

5VY-21668-00

9

⚠ WARNING

This unit contains high pressure nitrogen gas. Mishandling can cause explosion.

- Read owner's manual for instructions.
- Do not incinerate, puncture or open.

4AA-22259-80

DESCRIPTION

EAU10410

Left view

2

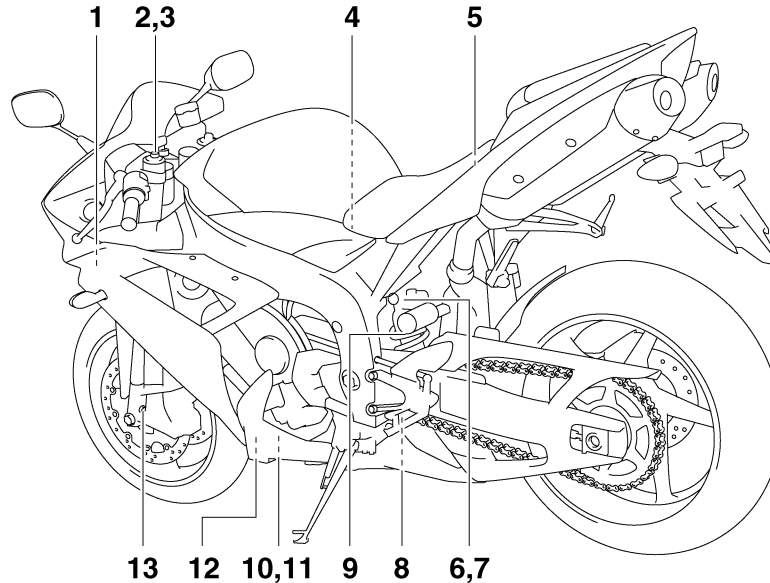

1. Fuse box (page 6-35)
2. Front fork rebound damping force adjusting screw (page 3-17)
3. Front fork spring preload adjusting bolt (page 3-17)
4. Fuel injection system fuse (page 6-35)
5. Main fuse (page 6-35)
6. Shock absorber assembly compression damping force adjusting bolt (for fast compression damping) (page 3-19)
7. Shock absorber assembly compression damping force adjusting bolt (for slow compression damping) (page 3-19)
8. Shock absorber assembly rebound damping force adjusting screw (page 3-19)
9. Shock absorber assembly spring preload adjusting ring (page 3-19)
10. Engine oil drain bolt (page 6-13)
11. Coolant drain bolt (page 6-17)
12. Engine oil filter cartridge (page 6-13)
13. Front fork compression damping force adjusting screw (page 3-17)

Right view

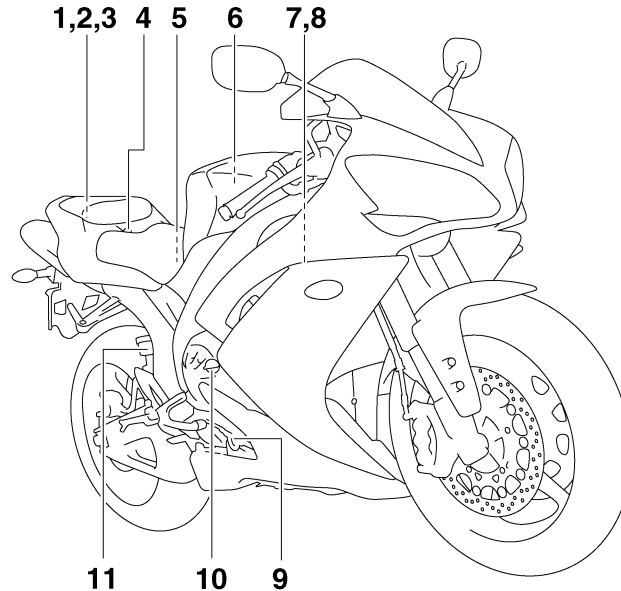

1. Luggage strap holder (page 3-21)
2. Helmet holder (page 3-16)
3. Owner's tool kit (page 6-1)
4. Passenger seat lock (page 3-15)
5. Battery (page 6-34)
6. Air filter element (page 6-19)
7. Radiator cap (page 6-16)
8. Coolant reservoir (page 6-16)

9. Engine oil level check window (page 6-13)
10. Engine oil filler cap (page 6-13)
11. Rear brake fluid reservoir (page 6-27)

DESCRIPTION

EAU10430

Controls and instruments

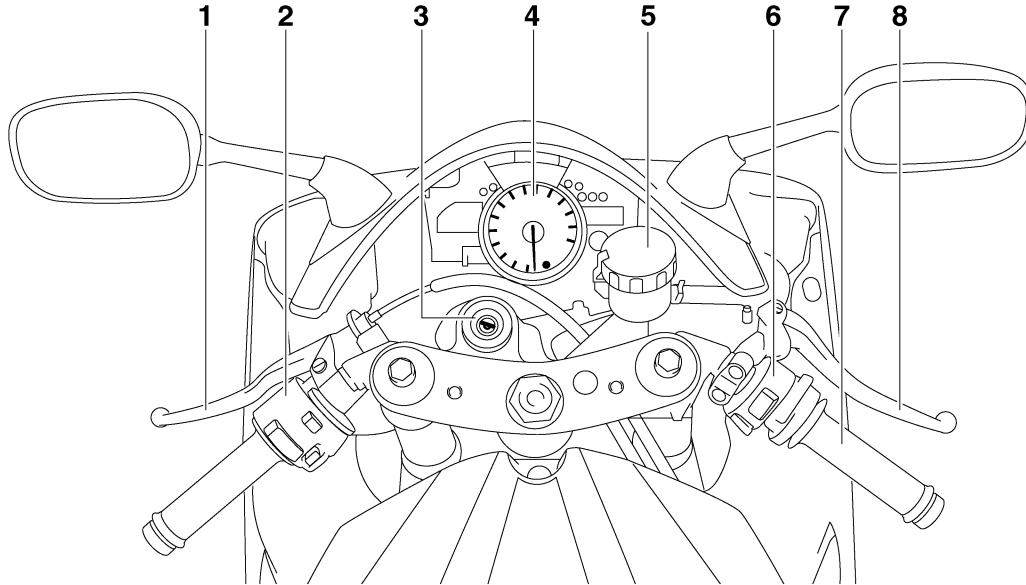

2

1. Clutch lever (page 3-12)
2. Left handlebar switches (page 3-11)
3. Main switch/steering lock (page 3-1)
4. Multi-function meter unit (page 3-5)
5. Front brake fluid reservoir (page 6-27)
6. Right handlebar switches (page 3-11)
7. Throttle grip (page 6-21)
8. Brake lever (page 3-12)

INSTRUMENT AND CONTROL FUNCTIONS

Main switch/steering lock

EAU10460

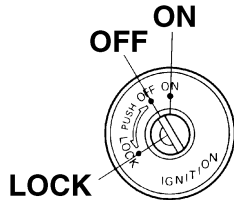

The main switch/steering lock controls the ignition and lighting systems, and is used to lock the steering. The various positions are described below.

ON

EAU10600

All electrical circuits are supplied with power, the meter lighting, taillight, license plate light, auxiliary lights and position lights come on, and the engine can be started. The key cannot be removed.

NOTE: _____

The headlights come on automatically when the engine is started and stay on until the key is turned to “OFF”, even if the engine stalls.

OFF

EAU10660

All electrical systems are off. The key can be removed.

LOCK

EAU10680

The steering is locked, and all electrical systems are off. The key can be removed.

To lock the steering

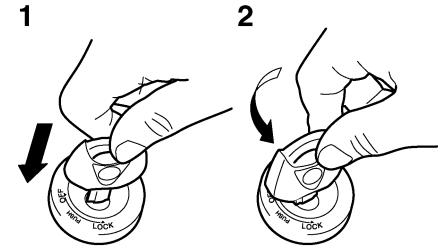

1. Push.
2. Turn.

1. Turn the handlebars all the way to the left.
2. Push the key in from the “OFF” position, and then turn it to “LOCK” while still pushing it.
3. Remove the key.

INSTRUMENT AND CONTROL FUNCTIONS

To unlock the steering

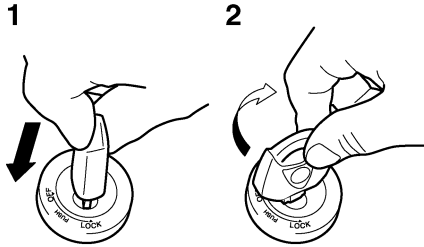

1. Push.
2. Turn.

Push the key in, and then turn it to “OFF” while still pushing it.

EWA10060

WARNING

Never turn the key to “OFF” or “LOCK” while the vehicle is moving, otherwise the electrical systems will be switched off, which may result in loss of control or an accident. Make sure that the vehicle is stopped before turning the key to “OFF” or “LOCK”.

Indicator and warning lights

EAU11003

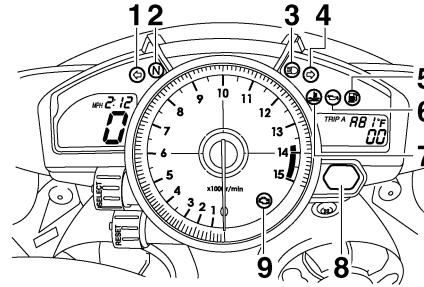

1. Left turn signal indicator light “←”
2. Neutral indicator light “N”
3. High beam indicator light “≡”
4. Right turn signal indicator light “→”
5. Fuel level warning light “⛽”
6. Oil level warning light “🛢️”
7. Coolant temperature warning light “🌡️”
8. Shift timing indicator light “T”
9. Engine trouble warning light “🚗”

Turn signal indicator lights “←” and “→”

EAU11030

The corresponding indicator light flashes when the turn signal switch is pushed to the left or right.

Neutral indicator light “N”

EAU11060

This indicator light comes on when the transmission is in the neutral position.

High beam indicator light “≡”

EAU11080

This indicator light comes on when the high beam of the headlight is switched on.

Oil level warning light “🛢️”

EAU11250

This warning light comes on when the engine oil level is low. The electrical circuit of the warning light can be checked by turning the key to “ON”.

If the warning light does not come on for a few seconds, then go off, have a Yamaha dealer check the electrical circuit.

NOTE:

- Even if the oil level is sufficient, the warning light may flicker when riding on a slope or during sudden acceleration or deceleration, but this is not a malfunction.

- This model is also equipped with a self-diagnosis device for the oil level detection circuit. If the oil level detection circuit is defective, the following cycle will be repeated until the malfunction is corrected: The oil level warning light will flash ten times, then go off for 2.5 seconds. If this occurs, have a Yamaha dealer check the vehicle.

NOTE: _____

This model is also equipped with a self-diagnosis device for the fuel level detection circuit. If the fuel level detection circuit is defective, the following cycle will be repeated until the malfunction is corrected: The fuel level warning light will flash eight times, and then go off for 3.0 seconds. If this occurs, have a Yamaha dealer check the vehicle.

CAUTION: _____

Do not operate the engine if it is overheated.

EAU11361

Fuel level warning light “”

This warning light comes on when the fuel level drops below approximately 3.2 L (0.85 US gal) (0.70 Imp.gal). When this occurs, refuel as soon as possible.

The electrical circuit of the warning light can be checked by turning the key to “ON”.

If the warning light does not come on for a few seconds, and then go off, have a Yamaha dealer check the electrical circuit.

EAU11423

Coolant temperature warning light**“”**

This warning light comes on when the engine overheats. When this occurs, stop the engine immediately and allow the engine to cool.

The electrical circuit of the warning light can be checked by turning the key to “ON”.

If the warning light does not come on for a few seconds, then go off, have a Yamaha dealer check the electrical circuit.

INSTRUMENT AND CONTROL FUNCTIONS

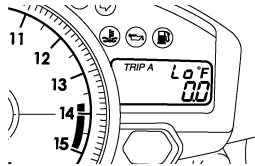
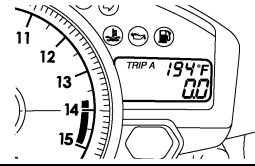
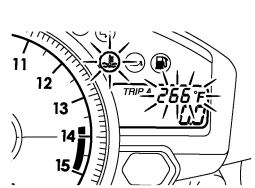
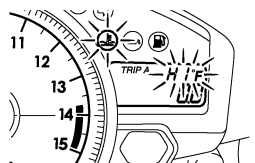
Coolant temperature	Display	Conditions	What to do
<p>Under 39 °C (Under 103 °F)</p>	 <p>The instrument cluster shows a coolant temperature gauge on the left with a needle pointing to approximately 13.5. To the right, a digital display shows 'Lo' and '00'. Above the display, the text 'TRIP A' is visible. Three indicator lights are shown above the display: a low oil pressure light, a battery light, and a neutral indicator light.</p>	<p>Message "Lo" is displayed.</p>	<p>OK. Go ahead with riding.</p>
<p>40–116 °C (104–242 °F)</p>	 <p>The instrument cluster shows a coolant temperature gauge on the left with a needle pointing to approximately 13.5. To the right, a digital display shows '194 F' and '00'. Above the display, the text 'TRIP A' is visible. Three indicator lights are shown above the display: a low oil pressure light, a battery light, and a neutral indicator light.</p>	<p>Temperature is displayed.</p>	<p>OK. Go ahead with riding.</p>
<p>117–139 °C (243–283 °F)</p>	 <p>The instrument cluster shows a coolant temperature gauge on the left with a needle pointing to approximately 14.5. To the right, a digital display shows '266 F' and '00'. Above the display, the text 'TRIP A' is visible. Three indicator lights are shown above the display: a low oil pressure light, a battery light, and a neutral indicator light. The low oil pressure light is flashing.</p>	<p>Temperature display flashes. Warning light comes on.</p>	<p>Stop the vehicle and allow it to idle until the coolant temperature goes down. If the temperature does not go down, stop the engine. (See page 6-47.)</p>
<p>Above 140 °C (Above 284 °F)</p>	 <p>The instrument cluster shows a coolant temperature gauge on the left with a needle pointing to approximately 15. To the right, a digital display shows 'HI' and '00'. Above the display, the text 'TRIP A' is visible. Three indicator lights are shown above the display: a low oil pressure light, a battery light, and a neutral indicator light. The low oil pressure light is flashing.</p>	<p>Message "HI" flashes. Warning light comes on.</p>	<p>Stop the engine and allow it to cool. (See page 6-47.)</p>

Engine trouble warning light “” EAU11530

This warning light comes on or flashes when an electrical circuit monitoring the engine is defective. When this occurs, have a Yamaha dealer check the self-diagnosis system. (See page 3-5 for an explanation of the self-diagnosis device.)

The electrical circuit of the warning light can be checked by turning the key to “ON”. If the warning light does not come on for a few seconds, then go off, have a Yamaha dealer check the electrical circuit.

Shift timing indicator light EAU11571

This indicator light can be set to come on and go off at the desired engine speeds and is used to inform the rider when it is time to shift to the next higher gear.

The electrical circuit of the indicator light can be checked by turning the key to “ON”.

If the indicator light does not come on for a few seconds, then go off, have a Yamaha dealer check the electrical cir-

cuit. (See page 3-5 for a detailed explanation of the function of this indicator light and on how to set it.)

Multi-function meter unit EAU34554

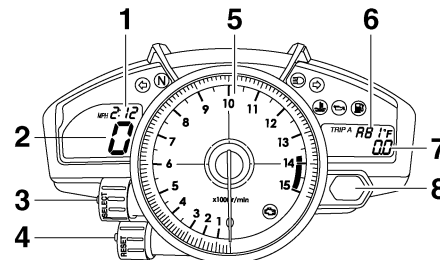

1. Clock
2. Speedometer
3. “SELECT” button
4. “RESET” button
5. Tachometer
6. Coolant temperature display/air intake temperature display
7. Odometer/tripmeters/fuel reserve tripmeter/stopwatch
8. Shift timing indicator light

WARNING

Be sure to stop the vehicle before making any setting changes to the multi-function meter unit.

The multi-function meter unit is equipped with the following:

INSTRUMENT AND CONTROL FUNCTIONS

ECA10031

- a speedometer (which shows the riding speed)
- a tachometer (which shows engine speed)
- an odometer (which shows the total distance traveled)
- two tripmeters (which show the distance traveled since they were last set to zero)
- a fuel reserve tripmeter (which shows the distance traveled since the fuel level warning light came on)
- a stopwatch
- a clock
- a coolant temperature display
- an air intake temperature display
- a self-diagnosis device
- a display brightness and shift timing indicator light control mode

NOTE:

- Be sure to turn the key to “ON” before using the “SELECT” and “RESET” buttons.

- To switch the speedometer and odometer/tripmeter displays between kilometers and miles, press the “SELECT” button for at least one second.

Tachometer

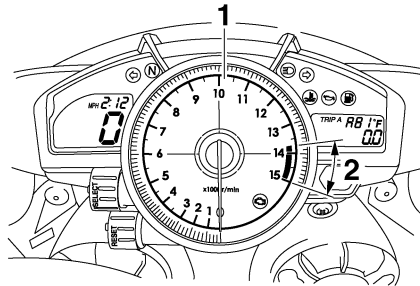

1. Tachometer
2. Tachometer red zone

The electric tachometer allows the rider to monitor the engine speed and keep it within the ideal power range.

When the key is turned to “ON”, the tachometer needle will sweep once across the r/min range and then return to zero r/min in order to test the electrical circuit.

CAUTION:

Do not operate the engine in the tachometer red zone.

Red zone: 13750 r/min and above

Clock mode

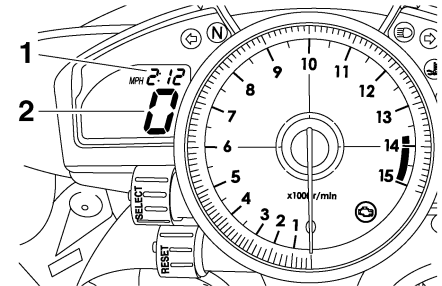

1. Clock
2. Speedometer

Turn the key to “ON”.

To set the clock

1. Push the “SELECT” button and “RESET” button together for at least two seconds.
2. When the hour digits start flashing, push the “RESET” button to set the hours.

INSTRUMENT AND CONTROL FUNCTIONS

3. Push the “SELECT” button, and the minute digits will start flashing.
4. Push the “RESET” button to set the minutes.
5. Push the “SELECT” button and then release it to start the clock.

Odometer, tripmeter, and stopwatch modes

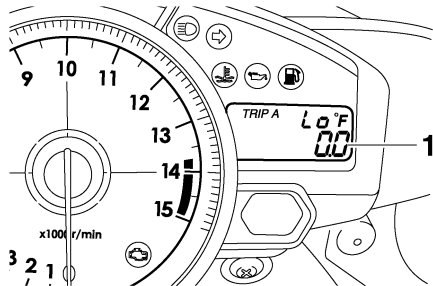

1. Odometer/tripmeters/fuel reserve tripmeter/stopwatch

Push the “SELECT” button to switch the display between the odometer mode “ODO”, the tripmeter modes “TRIP A” and “TRIP B” and the stopwatch mode in the following order: TRIP A → TRIP B → ODO → Stopwatch → TRIP A

If the fuel level warning light comes on (see page 3-2), the odometer display will automatically change to the fuel reserve tripmeter mode “F-TRIP” and start counting the distance traveled from that point. In that case, push the “SELECT” button to switch the display between the various tripmeter, odometer, and stopwatch modes in the following order:

F-TRIP → Stopwatch → TRIP A → TRIP B → ODO → F-TRIP

To reset a tripmeter, select it by pushing the “SELECT” button, and then push the “RESET” button for at least one second. If you do not reset the fuel reserve tripmeter manually, it will reset itself automatically and the display will return to the prior mode after refueling and traveling 5 km (3 mi).



Stopwatch mode

To change the display to the stopwatch mode, select it by pushing the “SELECT” button. (The stopwatch digits will start flashing.) Release the “SELECT” button, and then push it again for a few seconds until the stopwatch digits stop flashing.

Standard measurement

1. Push the “RESET” button to start the stopwatch.
2. Push the “SELECT” button to stop the stopwatch.
3. Push the “SELECT” button again to reset the stopwatch.

Split-time measurement

1. Push the “RESET” button to start the stopwatch.
2. Push the “RESET” button or start switch “” to measure split-times. (The colon “:” will start flashing.)
3. Push the “RESET” button or start switch “” to display the final split-time or push the “SELECT” button to stop the stopwatch and display total elapsed time.
4. Push the “SELECT” button to reset the stopwatch.

NOTE: _____
To change the display back to the prior mode, push the “SELECT” button for a few seconds.

INSTRUMENT AND CONTROL FUNCTIONS

Coolant temperature display

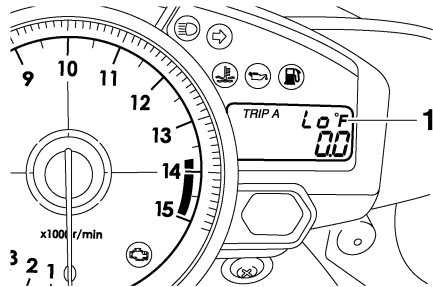

1. Coolant temperature display

The coolant temperature display indicates the temperature of the coolant. Push the “RESET” button to switch the coolant temperature display to the air intake temperature display.

NOTE:

When the coolant temperature display is selected, “C” is displayed for one second, and then the coolant temperature is displayed.

CAUTION:

Do not operate the engine if it is overheated.

ECA10020

Air intake temperature display

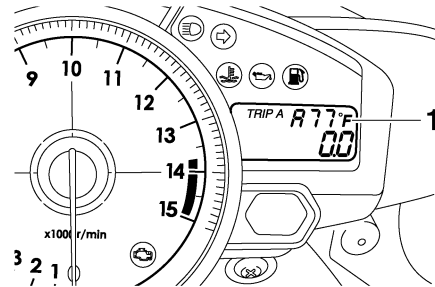

1. Air intake temperature display

The air intake temperature display indicates the temperature of the air drawn into the air filter case. Push the “RESET” button to switch the coolant temperature display to the air intake temperature display.

NOTE:

- Even if the air intake temperature is set to be displayed, the coolant temperature warning light comes on when the engine overheats.
- When the key is turned to “ON”, the coolant temperature is automatically displayed, even if the air intake temperature was displayed prior to turning the key to “OFF”.

- When the air intake temperature display is selected, “A” is displayed before the temperature.

Self-diagnosis devices

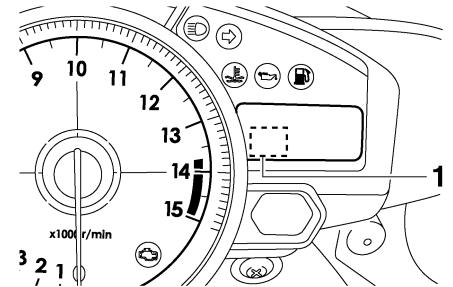

1. Error code display

This model is equipped with a self-diagnosis device for various electrical circuits.

If any of those circuits are defective, the engine trouble warning light will come on, and then the right display will indicate a two-digit error code.

If the right display indicates any error codes, note the code number, and then have a Yamaha dealer check the vehicle.

INSTRUMENT AND CONTROL FUNCTIONS

ECA11590

CAUTION:

If the display indicates an error code, the vehicle should be checked as soon as possible in order to avoid engine damage.

Display brightness and shift timing indicator light control mode

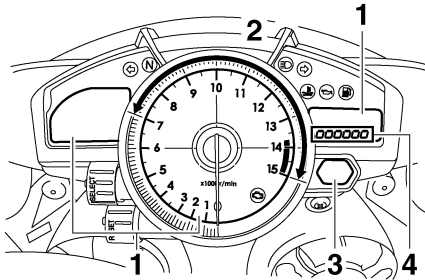

1. Display brightness
2. Shift timing indicator light activation/deactivation
3. Shift timing indicator light
4. Brightness level

This mode cycles through five control functions, allowing you to make the following settings in the order listed below.

- Display brightness:
This function allows you to adjust the brightness of the displays and tachometer to suit the outside lighting conditions.
- Shift timing indicator light activity:
This function allows you to choose whether or not the indicator light should be activated and whether it should flash or stay on when activated.
- Shift timing indicator light activation:
This function allows you to select the engine speed at which the indicator light will be activated.
- Shift timing indicator light deactivation:
This function allows you to select the engine speed at which the indicator light will be deactivated.
- Shift timing indicator light brightness:
This function allows you to adjust the brightness of the indicator light to suit your preference.

NOTE:

In this mode, the right display shows the current setting for each function (except the shift timing indicator light activity function).

To adjust the brightness of the multi-function meter displays and tachometer

1. Turn the key to "OFF".
2. Push and hold the "SELECT" button.
3. Turn the key to "ON", and then release the "SELECT" button after five seconds.
4. Push the "RESET" button to select the desired brightness level.
5. Push the "SELECT" button to confirm the selected brightness level. The control mode changes to the shift timing indicator light activity function.

To set the shift timing indicator light activity function

1. Push the "RESET" button to select one of the following indicator light activity settings:

INSTRUMENT AND CONTROL FUNCTIONS

3

- The indicator light will stay on when activated. (This setting is selected when the indicator light stays on.)
 - The indicator light will flash when activated. (This setting is selected when the indicator light flashes four times per second.)
 - The indicator light is deactivated; in other words, it will not come on or flash. (This setting is selected when the indicator light flashes once every two seconds.)
2. Push the “SELECT” button to confirm the selected indicator light activation function.

To set the shift timing indicator light activation function

NOTE: _____

The shift timing indicator light activation function can be set between 7000 r/min and 15000 r/min. From 7000 r/min to 12000 r/min, the indicator light can be

set in increments of 500 r/min. From 12000 r/min to 15000 r/min, the indicator light can be set in increments of 200 r/min.

1. Push the “RESET” button to select the desired engine speed for activating the indicator light.
2. Push the “SELECT” button to confirm the selected engine speed. The control mode changes to the shift timing indicator light deactivation function.

To set the shift timing indicator light deactivation function

NOTE: _____

- The shift timing indicator light deactivation function can be set between 7000 r/min and 15000 r/min. From 7000 r/min to 12000 r/min, the indicator light can be set in increments of 500 r/min. From 12000 r/min to 15000 r/min, the indicator light can be set in increments of 200 r/min.

- Be sure to set the deactivation function to a higher engine speed than for the activation function, otherwise the shift timing indicator light will remain deactivated.

1. Push the “RESET” button to select the desired engine speed for deactivating the indicator light.
2. Push the “SELECT” button to confirm the selected engine speed. The control mode changes to the shift timing indicator light brightness function.

To adjust the shift timing indicator light brightness

1. Push the “RESET” button to select the desired indicator light brightness level.
2. Push the “SELECT” button to confirm the selected indicator light brightness level. The right display will return to the odometer or trip-meter mode.

INSTRUMENT AND CONTROL FUNCTIONS

Handlebar switches

EAU12347

Left

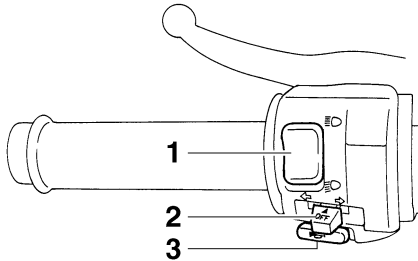

1. Dimmer switch “ \equiv 0/0 \equiv ”
2. Turn signal switch “ \leftarrow / \rightarrow ”
3. Horn switch “ H ”

Right

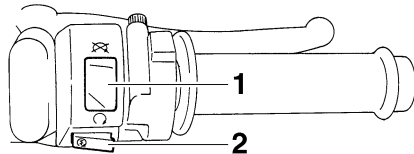

1. Engine stop switch “ \bigcirc / \otimes ”
2. Start switch “ S ”

Dimmer switch “ \equiv 0/0 \equiv ”

EAU12400

Set this switch to “ \equiv 0” for the high beam and to “0 \equiv ” for the low beam.

Turn signal switch “ \leftarrow / \rightarrow ”

EAU12460

To signal a right-hand turn, push this switch to “ \rightarrow ”. To signal a left-hand turn, push this switch to “ \leftarrow ”. When released, the switch returns to the center position. To cancel the turn signal lights, push the switch in after it has returned to the center position.

Horn switch “ H ”

EAU12500

Press this switch to sound the horn.

Engine stop switch “ \bigcirc / \otimes ”

EAU12660

Set this switch to “ \bigcirc ” before starting the engine. Set this switch to “ \otimes ” to stop the engine in case of an emergency, such as when the vehicle overturns or when the throttle cable is stuck.

Start switch “ S ”

EAU12710

Push this switch to crank the engine with the starter.

CAUTION:

See page 5-1 for starting instructions prior to starting the engine.

ECA10050

EAU41700

The engine trouble warning light will come on when the key is turned to “ON” and the start switch is pushed, but this does not indicate a malfunction.

INSTRUMENT AND CONTROL FUNCTIONS

Clutch lever

EAU12820

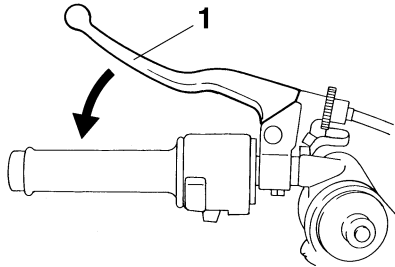

1. Clutch lever

The clutch lever is located at the left handlebar grip. To disengage the clutch, pull the lever toward the handlebar grip. To engage the clutch, release the lever. The lever should be pulled rapidly and released slowly for smooth clutch operation.

The clutch lever is equipped with a clutch switch, which is part of the ignition circuit cut-off system. (See page 3-22.)

Shift pedal

EAU12870

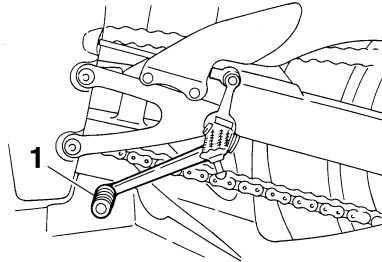

1. Shift pedal

The shift pedal is located on the left side of the engine and is used in combination with the clutch lever when shifting the gears of the 6-speed constant-mesh transmission equipped on this motorcycle.

Brake lever

EAU33850

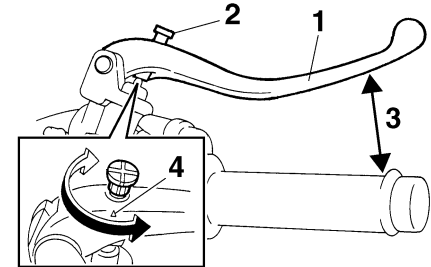

1. Brake lever

2. Brake lever position adjusting knob

3. Distance between brake lever and handlebar grip

4. "△" mark

The brake lever is located at the right handlebar grip. To apply the front brake, pull the lever toward the handlebar grip.

The brake lever is equipped with a position adjusting knob. To adjust the distance between the brake lever and the handlebar grip, turn the adjusting knob while holding the lever pushed away from the handlebar grip. When the desired position is obtained, be sure to set

INSTRUMENT AND CONTROL FUNCTIONS

it by aligning a groove on the adjusting knob with the “△” mark on the brake lever.

Brake pedal

EAU12941

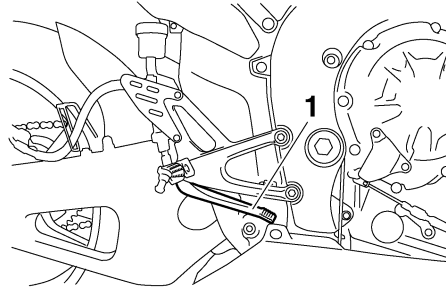

1. Brake pedal

The brake pedal is on the right side of the motorcycle. To apply the rear brake, press down on the brake pedal.

Fuel tank cap

EAU13072

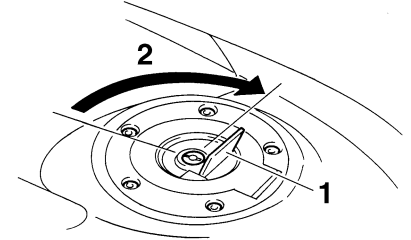

1. Fuel tank cap lock cover
2. Unlock.

To open the fuel tank cap

Open the fuel tank cap lock cover, insert the key into the lock, and then turn it 1/4 turn clockwise. The lock will be released and the fuel tank cap can be opened.

To close the fuel tank cap

1. Push the fuel tank cap into position with the key inserted in the lock.
2. Turn the key counterclockwise to the original position, remove it, and then close the lock cover.

INSTRUMENT AND CONTROL FUNCTIONS

NOTE: _____

The fuel tank cap cannot be closed unless the key is in the lock. In addition, the key cannot be removed if the cap is not properly closed and locked.

EWA11090

WARNING _____

Make sure that the fuel tank cap is properly closed before riding.

Fuel

EAU13220

ECA10070

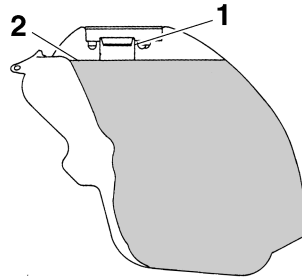

1. Fuel tank filler tube
2. Fuel level

Make sure that there is sufficient fuel in the tank. When refueling, be sure to insert the pump nozzle into the fuel tank filler hole and to fill the tank to the bottom of the filler tube as shown.

EWA10880

WARNING _____

- Do not overfill the fuel tank, otherwise it may overflow when the fuel warms up and expands.
- Avoid spilling fuel on the hot engine.

CAUTION: _____

Immediately wipe off spilled fuel with a clean, dry, soft cloth, since fuel may deteriorate painted surfaces or plastic parts.

EAU13380

Recommended fuel:

PREMIUM UNLEADED GASOLINE ONLY

Fuel tank capacity:

18.0 L (4.76 US gal) (3.96 Imp.gal)

Fuel reserve amount (when the fuel level warning light comes on):

3.2 L (0.85 US gal) (0.70 Imp.gal)

ECA11400

CAUTION: _____

Use only unleaded gasoline. The use of leaded gasoline will cause severe damage to internal engine parts, such as the valves and piston rings, as well as to the exhaust system.

Your Yamaha engine has been designed to use premium unleaded gasoline with a pump octane number [(R+M)/2] of 91 or higher, or a research

octane number of 95 or higher. If knocking (or pinging) occurs, use a gasoline of a different brand. Use of unleaded fuel will extend spark plug life and reduce maintenance costs.

Gasohol

There are two types of gasohol: gasohol containing ethanol and that containing methanol. Gasohol containing ethanol can be used if the ethanol content does not exceed 10%. Gasohol containing methanol is not recommended by Yamaha because it can cause damage to the fuel system or vehicle performance problems.

Catalytic converter

EAU13431

This model is equipped with a catalytic converter in the exhaust system.

EWA10860

⚠ WARNING

The exhaust system is hot after operation. Make sure that the exhaust system has cooled down before doing any maintenance work.

ECA10700

CAUTION:

The following precautions must be observed to prevent a fire hazard or other damages.

- **Use only unleaded gasoline. The use of leaded gasoline will cause unreparable damage to the catalytic converter.**
- **Never park the vehicle near possible fire hazards such as grass or other materials that easily burn.**
- **Do not allow the engine to idle too long.**

Seats

EAU33861

Rider seat

To remove the rider seat

Pull back the rear of the rider seat as shown, remove the bolts, and then pull the seat off.

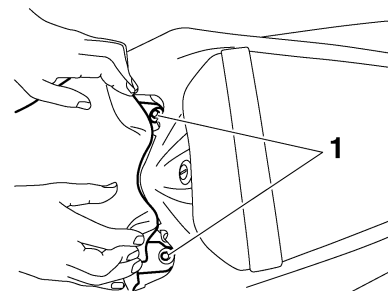

1. Bolt

To install the rider seat

Insert the projection on the front of the rider seat into the seat holder as shown, place the seat in the original position, and then install the bolts.

INSTRUMENT AND CONTROL FUNCTIONS

EAU33870

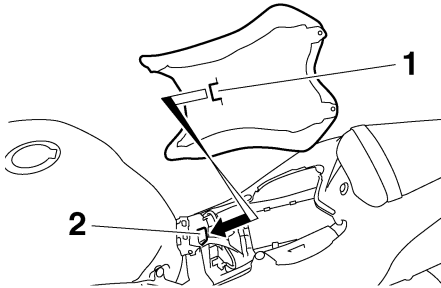

1. Projection
2. Seat holder

Passenger seat

To remove the passenger seat

1. Insert the key into the seat lock, and then turn it clockwise.

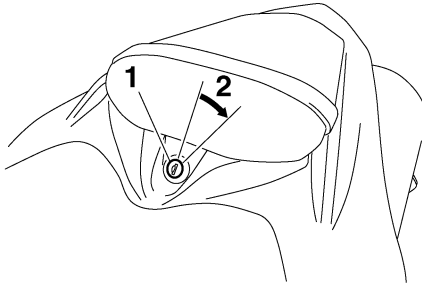

1. Passenger seat lock
2. Unlock.

2. Lift the front of the passenger seat and pull it forward.

To install the passenger seat

1. Insert the projection on the rear of the passenger seat into the seat holder as shown, and then push the front of the seat down to lock it in place.

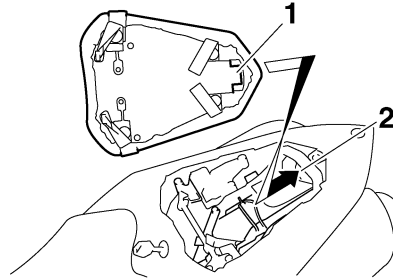

1. Projection
2. Seat holder

2. Remove the key.

NOTE:

Make sure that the seats are properly secured before riding.

Helmet holders

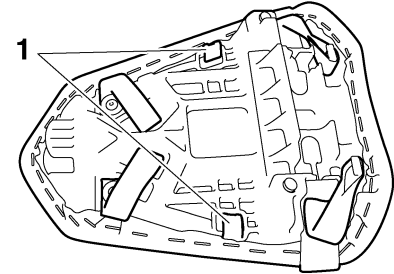

1. Helmet holder

The helmet holders are located on the bottom of the passenger seat.

To secure a helmet to a helmet holder

1. Remove the passenger seat. (See page 3-15.)
2. Attach the helmet to a helmet holder, and then securely install the passenger seat.

EWA11040

! WARNING

Never ride with a helmet attached to a helmet holder, since the helmet may hit objects, causing loss of control and possibly an accident.

INSTRUMENT AND CONTROL FUNCTIONS

To release a helmet from a helmet holder

Remove the passenger seat, remove the helmet from the helmet holder, and then install the seat.

Adjusting the front fork

EAU14741

This front fork is equipped with spring preload adjusting bolts, rebound damping force adjusting screws and compression damping force adjusting screws.

EWA10180

WARNING

Always adjust both fork legs equally, otherwise poor handling and loss of stability may result.

Spring preload

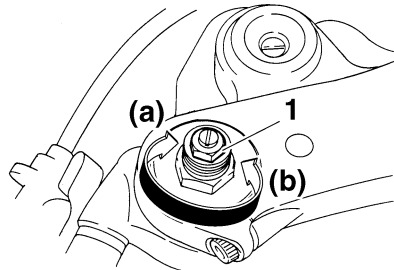

1. Spring preload adjusting bolt

To increase the spring preload and thereby harden the suspension, turn the adjusting bolt on each fork leg in direction (a). To decrease the spring pre-

load and thereby soften the suspension, turn the adjusting bolt on each fork leg in direction (b).

NOTE: _____
Align the appropriate groove on the adjusting mechanism with the top of the front fork cap bolt.

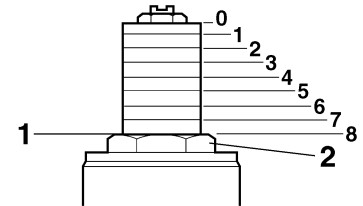

1. Current setting
2. Front fork cap bolt

Spring preload setting:

Minimum (soft):

8

Standard:

5

Maximum (hard):

0

INSTRUMENT AND CONTROL FUNCTIONS

ECA10100

Rebound damping force

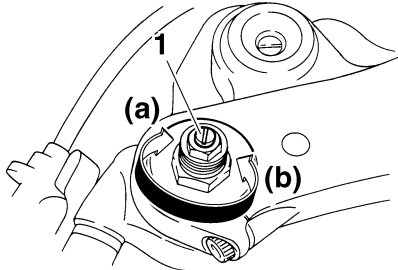

1. Rebound damping force adjusting screw

To increase the rebound damping force and thereby harden the rebound damping, turn the adjusting screw on each fork leg in direction (a). To decrease the rebound damping force and thereby soften the rebound damping, turn the adjusting screw on each fork leg in direction (b).

Rebound damping setting:

Minimum (soft):

26 click(s) in direction (b)*

Standard:

10 click(s) in direction (b)*

Maximum (hard):

1 click(s) in direction (b)*

* With the adjusting screw fully turned in direction (a)

Compression damping force

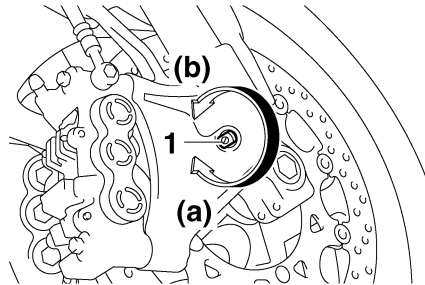

1. Compression damping force adjusting screw

To increase the compression damping force and thereby harden the compression damping, turn the adjusting screw on each fork leg in direction (a). To decrease the compression damping force and thereby soften the compression damping, turn the adjusting screw on each fork leg in direction (b).

Compression damping setting:

Minimum (soft):

25 click(s) in direction (b)*

Standard:

10 click(s) in direction (b)*

Maximum (hard):

1 click(s) in direction (b)*

* With the adjusting screw fully turned in direction (a)

CAUTION:

Never attempt to turn an adjusting mechanism beyond the maximum or minimum settings.

NOTE:

Although the total number of clicks of a damping force adjusting mechanism may not exactly match the above specifications due to small differences in production, the actual number of clicks always represents the entire adjusting range. To obtain a precise adjustment, it would be advisable to check the number of clicks of each damping force adjusting mechanism and to modify the specifications as necessary.

Adjusting the shock absorber assembly

EAU42940

This shock absorber assembly is equipped with a spring preload adjusting ring, a rebound damping force adjusting screw, a compression damping force adjusting bolt (for fast compression damping) and a compression damping force adjusting bolt (for slow compression damping).

ECA10100

CAUTION:

Never attempt to turn an adjusting mechanism beyond the maximum or minimum settings.

Spring preload

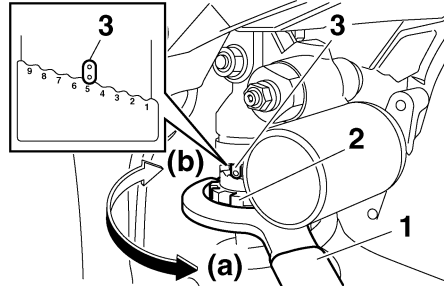

1. Special wrench
2. Spring preload adjusting ring
3. Position indicator

To increase the spring preload and thereby harden the suspension, turn the adjusting ring in direction (a). To decrease the spring preload and thereby soften the suspension, turn the adjusting ring in direction (b).

NOTE:

- Align the appropriate notch in the adjusting ring with the position indicator on the shock absorber.
- Use the special wrench included in the owner's tool kit to make the adjustment.

Spring preload setting:

Minimum (soft):

1

Standard:

5

Maximum (hard):

9

Rebound damping force

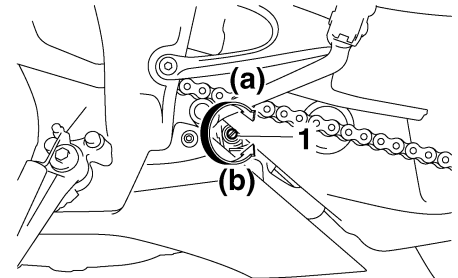

1. Rebound damping force adjusting screw

To increase the rebound damping force and thereby harden the rebound damping, turn the adjusting screw in direction (a). To decrease the rebound damping force and thereby soften the rebound damping, turn the adjusting screw in direction (b).

INSTRUMENT AND CONTROL FUNCTIONS

Rebound damping setting:

Minimum (soft):

20 click(s) in direction (b)*

Standard:

12 click(s) in direction (b)*

Maximum (hard):

3 click(s) in direction (b)*

* With the adjusting screw fully turned in direction (a)

direction (a). To decrease the compression damping force and thereby soften the compression damping, turn the adjusting bolt in direction (b).

Compression damping setting (for fast compression damping):

Minimum (soft):

4 turn(s) in direction (b)*

Standard:

3 turn(s) in direction (b)*

Maximum (hard):

0 turn(s) in direction (b)*

* With the adjusting bolt fully turned in direction (a)

Compression damping setting (for slow compression damping):

Minimum (soft):

20 click(s) in direction (b)*

Standard:

12 click(s) in direction (b)*

Maximum (hard):

1 click(s) in direction (b)*

* With the adjusting bolt fully turned in direction (a)

3

Compression damping force

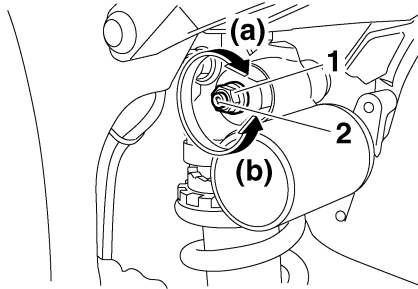

1. Compression damping force adjusting bolt (for fast compression damping)
2. Compression damping force adjusting bolt (for slow compression damping)

Compression damping force (for fast compression damping)

To increase the compression damping force and thereby harden the compression damping, turn the adjusting bolt in

Compression damping force (for slow compression damping)

To increase the compression damping force and thereby harden the compression damping, turn the adjusting bolt in direction (a). To decrease the compression damping force and thereby soften the compression damping, turn the adjusting bolt in direction (b).

NOTE:

Although the total number of clicks or turns of a damping force adjusting mechanism may not exactly match the specifications listed due to small differences in production, the actual number of clicks or turns always represents the entire adjustment range. To obtain a precise adjustment, it would be advisable to check the number of clicks or turns of each damping force adjusting mechanism and to modify the specifications as necessary.

EWA10220



This shock absorber contains highly pressurized nitrogen gas. For proper handling, read and understand

the following information before handling the shock absorber. The manufacturer cannot be held responsible for property damage or personal injury that may result from improper handling.

- Do not tamper with or attempt to open the gas cylinder.
- Do not subject the shock absorber to an open flame or other high heat sources, otherwise it may explode due to excessive gas pressure.
- Do not deform or damage the gas cylinder in any way, as this will result in poor damping performance.
- Always have a Yamaha dealer service the shock absorber.

Luggage strap holders

EAU15181

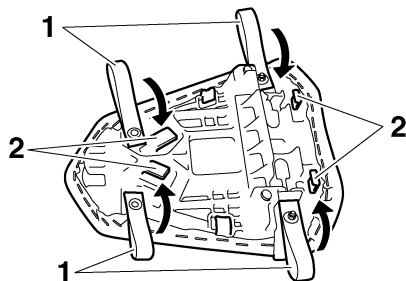

1. Luggage strap holder
2. Hook

There are four luggage strap holders on the bottom of the passenger seat. To use the strap holders, remove the passenger seat, unhook the straps from the hooks, and then install the seat with the straps hanging out from under the passenger seat. (See page 3-15.)

EXUP system

EAU15281

This model is equipped with Yamaha's EXUP (EXhaust Ultimate Power valve) system. This system boosts engine power by means of a valve that regulates the diameter of the exhaust pipe. The EXUP system valve is constantly adjusted in accordance with the engine speed by a computer-controlled servomotor.

3

CAUTION:

- The EXUP system has been set and extensively tested at the Yamaha factory. Changing these settings without sufficient technical knowledge may result in poor performance of or damage to the engine.
- If the EXUP system cannot be heard when the main switch is turned on, have a Yamaha dealer check it.

INSTRUMENT AND CONTROL FUNCTIONS

Sidestand

EAU15301

The sidestand is located on the left side of the frame. Raise the sidestand or lower it with your foot while holding the vehicle upright.

NOTE:

The built-in sidestand switch is part of the ignition circuit cut-off system, which cuts the ignition in certain situations. (See further down for an explanation of the ignition circuit cut-off system.)

3

WARNING

EWA10240

The vehicle must not be ridden with the sidestand down, or if the sidestand cannot be properly moved up (or does not stay up), otherwise the sidestand could contact the ground and distract the operator, resulting in a possible loss of control. Yamaha's ignition circuit cut-off system has been designed to assist the operator in fulfilling the responsibility of raising the sidestand before starting off. Therefore, check this system regularly as described

below and have a Yamaha dealer repair it if it does not function properly.

Ignition circuit cut-off system

EAU15311

The ignition circuit cut-off system (comprising the sidestand switch, clutch switch and neutral switch) has the following functions.

- It prevents starting when the transmission is in gear and the sidestand is up, but the clutch lever is not pulled.
- It prevents starting when the transmission is in gear and the clutch lever is pulled, but the sidestand is still down.
- It cuts the running engine when the transmission is in gear and the sidestand is moved down.

Periodically check the operation of the ignition circuit cut-off system according to the following procedure.

WARNING

EWA10250

If a malfunction is noted, have a Yamaha dealer check the system before riding.

INSTRUMENT AND CONTROL FUNCTIONS

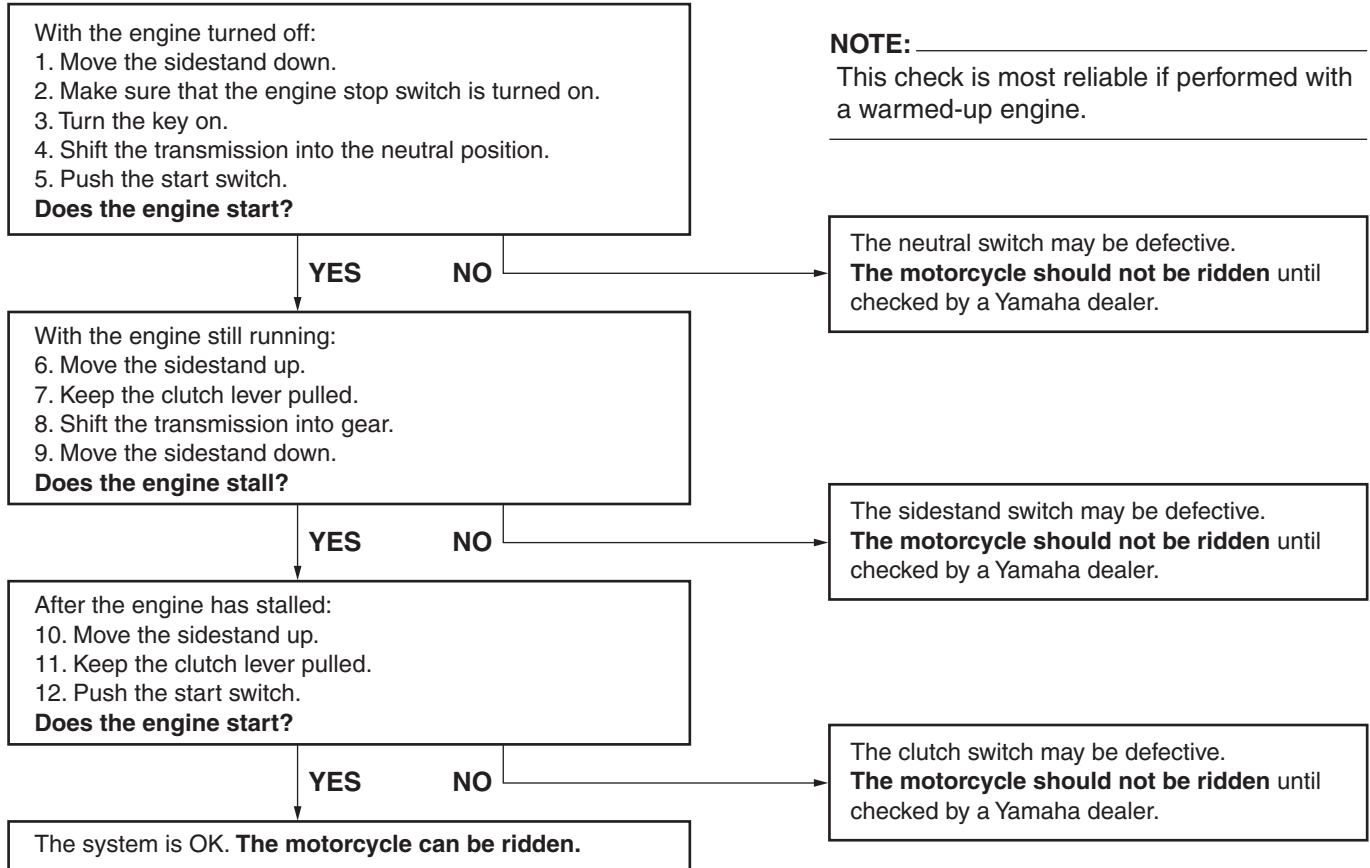

PRE-OPERATION CHECKS

EAU15592

The condition of a vehicle is the owner's responsibility. Vital components can start to deteriorate quickly and unexpectedly, even if the vehicle remains unused (for example, as a result of exposure to the elements). Any damage, fluid leakage or loss of tire air pressure could have serious consequences. Therefore, it is very important, in addition to a thorough visual inspection, to check the following points before each ride.

NOTE:

Pre-operation checks should be made each time the vehicle is used. Such an inspection can be accomplished in a very short time; and the added safety it assures is more than worth the time involved.

EWA11150

4



If any item in the Pre-operation check list is not working properly, have it inspected and repaired before operating the vehicle.

PRE-OPERATION CHECKS

EAU15605

Pre-operation check list

ITEM	CHECKS	PAGE
Fuel	<ul style="list-style-type: none">• Check fuel level in fuel tank.• Refuel if necessary.• Check fuel line for leakage.	3-14
Engine oil	<ul style="list-style-type: none">• Check oil level in engine.• If necessary, add recommended oil to specified level.• Check vehicle for oil leakage.	6-13
Coolant	<ul style="list-style-type: none">• Check coolant level in reservoir.• If necessary, add recommended coolant to specified level.• Check cooling system for leakage.	6-16
Front brake	<ul style="list-style-type: none">• Check operation.• If soft or spongy, have Yamaha dealer bleed hydraulic system.• Check brake pads for wear.• Replace if necessary.• Check fluid level in reservoir.• If necessary, add recommended brake fluid to specified level.• Check hydraulic system for leakage.	6-26, 6-27
Rear brake	<ul style="list-style-type: none">• Check operation.• If soft or spongy, have Yamaha dealer bleed hydraulic system.• Check brake pads for wear.• Replace if necessary.• Check fluid level in reservoir.• If necessary, add recommended brake fluid to specified level.• Check hydraulic system for leakage.	6-26, 6-27
Clutch	<ul style="list-style-type: none">• Check operation.• Lubricate cable if necessary.• Check lever free play.• Adjust if necessary.	6-25

PRE-OPERATION CHECKS

ITEM	CHECKS	PAGE
Throttle grip	<ul style="list-style-type: none"> • Make sure that operation is smooth. • Check cable free play. • If necessary, have Yamaha dealer adjust cable free play and lubricate cable and grip housing. 	6-21, 6-30
Control cables	<ul style="list-style-type: none"> • Make sure that operation is smooth. • Lubricate if necessary. 	6-30
Drive chain	<ul style="list-style-type: none"> • Check chain slack. • Adjust if necessary. • Check chain condition. • Lubricate if necessary. 	6-28, 6-29
Wheels and tires	<ul style="list-style-type: none"> • Check for damage. • Check tire condition and tread depth. • Check air pressure. • Correct if necessary. 	6-22, 6-24
Shift pedal	<ul style="list-style-type: none"> • Make sure that operation is smooth. • Correct if necessary. 	—
Brake pedal	<ul style="list-style-type: none"> • Make sure that operation is smooth. • Correct if necessary. 	—
Brake and clutch levers	<ul style="list-style-type: none"> • Make sure that operation is smooth. • Lubricate lever pivoting points if necessary. 	6-31
Sidestand	<ul style="list-style-type: none"> • Make sure that operation is smooth. • Lubricate pivot if necessary. 	6-32
Chassis fasteners	<ul style="list-style-type: none"> • Make sure that all nuts, bolts and screws are properly tightened. • Tighten if necessary. 	—
Instruments, lights, signals and switches	<ul style="list-style-type: none"> • Check operation. • Correct if necessary. 	—
Sidestand switch	<ul style="list-style-type: none"> • Check operation of ignition circuit cut-off system. • If system is defective, have Yamaha dealer check vehicle. 	3-22

OPERATION AND IMPORTANT RIDING POINTS

EAU15950

EWA10270

WARNING

- Become thoroughly familiar with all operating controls and their functions before riding. Consult a Yamaha dealer regarding any control or function that you do not thoroughly understand.
- Never start the engine or operate it in a closed area for any length of time. Exhaust fumes are poisonous, and inhaling them can cause loss of consciousness and death within a short time. Always make sure that there is adequate ventilation.
- Before starting out, make sure that the sidestand is up. If the sidestand is not raised completely, it could contact the ground and distract the operator, resulting in a possible loss of control.

Starting the engine

In order for the ignition circuit cut-off system to enable starting, one of the following conditions must be met:

- The transmission is in the neutral position.
- The transmission is in gear with the clutch lever pulled and the sidestand up.

WARNING

- Before starting the engine, check the function of the ignition circuit cut-off system according to the procedure described on page 3-22.
- Never ride with the sidestand down.

1. Turn the key to "ON" and make sure that the engine stop switch is set to "○".

CAUTION:

The following warning lights and indicator light should come on for a few seconds, then go off.

- Oil level warning light
- Fuel level warning light

EAU16251

- Coolant temperature warning light
- Shift timing indicator light
- Engine trouble warning light

If a warning or indicator light does not go off, see page 3-2 for the corresponding warning and indicator light circuit check.

2. Shift the transmission into the neutral position.

NOTE:

When the transmission is in the neutral position, the neutral indicator light should be on, otherwise have a Yamaha dealer check the electrical circuit.

3. Start the engine by pushing the start switch.

NOTE:

If the engine fails to start, release the start switch, wait a few seconds, and then try again. Each starting attempt should be as short as possible to preserve the battery. Do not crank the engine more than 10 seconds on any one attempt.

OPERATION AND IMPORTANT RIDING POINTS

ECA11130

CAUTION:

For maximum engine life, always warm the engine up before starting off. Never accelerate hard when the engine is cold!

NOTE:

The engine is warm when it quickly responds to the throttle.

EAU16671

Shifting

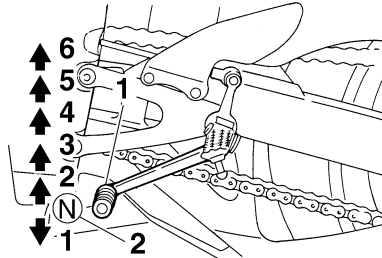

1. Shift pedal
2. Neutral position

Shifting gears lets you control the amount of engine power available for starting off, accelerating, climbing hills, etc.

The gear positions are shown in the illustration.

NOTE:

To shift the transmission into the neutral position, press the shift pedal down repeatedly until it reaches the end of its travel, and then slightly raise it.

ECA10260

CAUTION:

- Even with the transmission in the neutral position, do not coast for long periods of time with the engine off, and do not tow the motorcycle for long distances. The transmission is properly lubricated only when the engine is running. Inadequate lubrication may damage the transmission.
- Always use the clutch while changing gears to avoid damaging the engine, transmission, and drive train, which are not designed to withstand the shock of forced shifting.

EAU16680

To start out and accelerate

1. Pull the clutch lever to disengage the clutch.
2. Shift the transmission into first gear. The neutral indicator light should go out.
3. Open the throttle gradually, and at the same time, release the clutch lever slowly.

OPERATION AND IMPORTANT RIDING POINTS

4. At the recommended shift points shown in the following table, close the throttle, and at the same time, quickly pull the clutch lever in.
5. Shift the transmission into second gear. (Make sure not to shift the transmission into the neutral position.)
6. Open the throttle part way and gradually release the clutch lever.
7. Follow the same procedure when shifting to the next higher gear.

NOTE: _____
Always shift gears at the recommended shift points.

EAU16700

To decelerate

1. Apply both the front and the rear brakes to slow the motorcycle.
2. Shift the transmission into first gear when the motorcycle reaches 25 km/h (15.5 mi/h). If the engine is about to stall or runs very roughly, pull the clutch lever in and use the brakes to stop the motorcycle.

3. Shift the transmission into the neutral position when the motorcycle is almost completely stopped. The neutral indicator light should come on.

EAU16740

Recommended shift points

The recommended shift points during acceleration and deceleration are shown in the table below.

Shift up points:

- 1st → 2nd: 20 km/h (12.5 mi/h)
- 2nd → 3rd: 30 km/h (18.8 mi/h)
- 3rd → 4th: 40 km/h (25.0 mi/h)
- 4th → 5th: 50 km/h (31.3 mi/h)
- 5th → 6th: 60 km/h (37.5 mi/h)

Shift down points:

- 6th → 5th: 25 km/h (15.5 mi/h)
- 5th → 4th: 25 km/h (15.5 mi/h)
- 4th → 3rd: 25 km/h (15.5 mi/h)
- 3rd → 2nd: 25 km/h (15.5 mi/h)
- 2nd → 1st: —

EAU16841

Engine break-in

There is never a more important period in the life of your engine than the period between 0 and 1600 km (1000 mi). For this reason, you should read the following material carefully.

Since the engine is brand new, do not put an excessive load on it for the first 1600 km (1000 mi). The various parts in the engine wear and polish themselves to the correct operating clearances. During this period, prolonged full-throttle operation or any condition that might result in engine overheating must be avoided.

EAU17081

0–1000 km (0–600 mi)

Avoid prolonged operation above 6900 r/min.

1000–1600 km (600–1000 mi)

Avoid prolonged operation above 8300 r/min.

OPERATION AND IMPORTANT RIDING POINTS

ECA10301

CAUTION:

After 1000 km (600 mi) of operation, the engine oil must be changed and the oil filter cartridge or element replaced.

1600 km (1000 mi) and beyond

The vehicle can now be operated normally.

ECA10310

CAUTION:

- Keep the engine speed out of the tachometer red zone.
- If any engine trouble should occur during the engine break-in period, immediately have a Yamaha dealer check the vehicle.

NOTE:

During and after the engine break-in period, the exhaust heat may cause discoloration of the exhaust pipe, but this is normal.

EAU17212

Parking

When parking, stop the engine, and then remove the key from the main switch.

EWA10310

WARNING

- Since the engine and exhaust system can become very hot, park in a place where pedestrians or children are not likely to touch them.
- Do not park on a slope or on soft ground, otherwise the vehicle may overturn.

ECA10380

CAUTION:

Never park in an area where there are fire hazards such as grass or other flammable materials.

EAU17231

Safety is an obligation of the owner. Periodic inspection, adjustment and lubrication will keep your vehicle in the safest and most efficient condition possible. The most important points of motorcycle inspection, adjustment, and lubrication are explained on the following pages.

Maintenance, replacement, or repair of the emission control devices and systems may be performed by any repair establishment or individual that is certified (if applicable).

EWA10320



If you are not familiar with maintenance work, have a Yamaha dealer do it for you.

PERIODIC MAINTENANCE

PROPER PERIODIC MAINTENANCE OF YOUR VEHICLE IS IMPORTANT IN ORDER TO ENJOY LONG, PLEASURABLE SERVICE. ESPECIALLY IMPORTANT ARE THE MAINTENANCE SERVICES RELATED TO EMISSIONS CONTROL. THESE CONTROLS NOT ONLY FUNCTION TO ENSURE CLEANER AIR, BUT ARE ALSO VITAL TO PROPER ENGINE OPERATION AND MAXIMUM PERFORMANCE. IN THE FOLLOWING PERIODIC MAINTENANCE CHARTS, THE SERVICES RELATED TO EMISSIONS CONTROL ARE GROUPED SEPARATELY. THESE SERVICES REQUIRE SPECIALIZED DATA, KNOWLEDGE, AND EQUIPMENT. YAMAHA DEALERS ARE TRAINED AND EQUIPPED TO PERFORM THESE PARTICULAR SERVICES.

EAU17301

Owner's tool kit

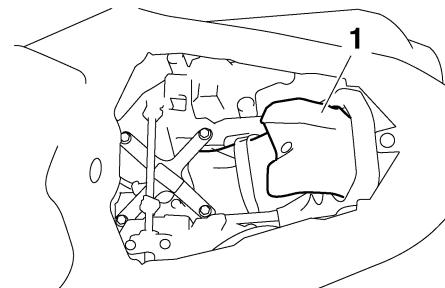

1. Owner's tool kit

The owner's tool kit is located under the passenger seat. (See page 3-15.)

The service information included in this manual and the tools provided in the owner's tool kit are intended to assist you in the performance of preventive maintenance and minor repairs. However, additional tools such as a torque wrench may be necessary to perform certain maintenance work correctly.

NOTE:

If you do not have the tools or experience required for a particular job, have a Yamaha dealer perform it for you.

PERIODIC MAINTENANCE AND MINOR REPAIR

EWA10340

WARNING

Modifications not approved by Yamaha may cause loss of performance, excessive emissions, and render the vehicle unsafe for use. Consult a Yamaha dealer before attempting any changes.

EWA12371

WARNING

Do not touch either muffler bracket, located under the muffler bracket covers, until the exhaust system has cooled.

6

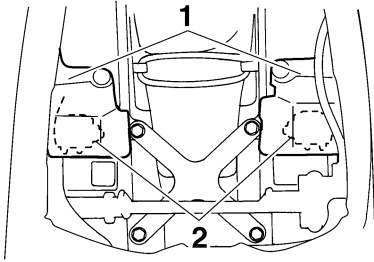

1. Muffler bracket cover
2. Muffler bracket

PERIODIC MAINTENANCE AND MINOR REPAIR

EAU17600

Periodic maintenance chart for the emission control system

No.	ITEM	ROUTINE	INITIAL	ODOMETER READINGS					
			600 mi (1000 km) or 1 month	4000 mi (7000 km) or 6 months	8000 mi (13000 km) or 12 months	12000 mi (19000 km) or 18 months	16000 mi (25000 km) or 24 months	20000 mi (31000 km) or 30 months	
1	*	Fuel line	<ul style="list-style-type: none"> • Check fuel hoses for cracks or damage. • Replace if necessary. 		√	√	√	√	√
2	*	Spark plugs	<ul style="list-style-type: none"> • Check condition. • Adjust gap and clean. • Replace every 8000 mi (13000 km) or 12 months. 		√	Replace.	√	Replace.	√
3	*	Valve clearance	<ul style="list-style-type: none"> • Check and adjust valve clearance when engine is cold. 	Every 26600 mi (42000 km)					
4	*	Crankcase breather system	<ul style="list-style-type: none"> • Check breather hose for cracks or damage. • Replace if necessary. 		√	√	√	√	√
5	*	Fuel injection	<ul style="list-style-type: none"> • Adjust synchronization. 		√	√	√	√	√
6	*	Exhaust system	<ul style="list-style-type: none"> • Check for leakage. • Tighten if necessary. • Replace gasket(s) if necessary. 		√	√	√	√	√
7	*	Evaporative emission control system (For California only)	<ul style="list-style-type: none"> • Check control system for damage. • Replace if necessary. 				√		√
8	*	Air induction system	<ul style="list-style-type: none"> • Check the air cut-off valve, reed valve, and hose for damage. • Replace any damaged parts if necessary. 				√		√

* Since these items require special tools, data and technical skills, have a Yamaha dealer perform the service.

PERIODIC MAINTENANCE AND MINOR REPAIR

EAU32183

General maintenance and lubrication chart

No.	ITEM	ROUTINE	INITIAL	ODOMETER READINGS					
			600 mi (1000 km) or 1 month	4000 mi (7000 km) or 6 months	8000 mi (13000 km) or 12 months	12000 mi (19000 km) or 18 months	16000 mi (25000 km) or 24 months	20000 mi (31000 km) or 30 months	
1	*	Air filter element	<ul style="list-style-type: none"> • Check condition and damage. • Replace if necessary. 		√	√	√	√	√
2	*	Clutch	<ul style="list-style-type: none"> • Check operation. • Adjust or replace cable. 	√	√	√	√	√	√
3	*	Front brake	<ul style="list-style-type: none"> • Check operation, fluid level, and for fluid leakage. • Replace brake pads if necessary. 	√	√	√	√	√	√
4	*	Rear brake	<ul style="list-style-type: none"> • Check operation, fluid level, and for fluid leakage. • Replace brake pads if necessary. 	√	√	√	√	√	√
5	*	Brake hoses	<ul style="list-style-type: none"> • Check for cracks or damage. • Replace. 		√	√	√	√	√
			Every 4 years						
6	*	Wheels	<ul style="list-style-type: none"> • Check runout and for damage. • Replace if necessary. 		√	√	√	√	√
7	*	Tires	<ul style="list-style-type: none"> • Check tread depth and for damage. • Replace if necessary. • Check air pressure. • Correct if necessary. 		√	√	√	√	√
8	*	Wheel bearings	<ul style="list-style-type: none"> • Check bearings for smooth operation. • Replace if necessary. 		√	√	√	√	√

PERIODIC MAINTENANCE AND MINOR REPAIR

No.	ITEM	ROUTINE	INITIAL	ODOMETER READINGS					
			600 mi (1000 km) or 1 month	4000 mi (7000 km) or 6 months	8000 mi (13000 km) or 12 months	12000 mi (19000 km) or 18 months	16000 mi (25000 km) or 24 months	20000 mi (31000 km) or 30 months	
9	* Swingarm pivot bearings	<ul style="list-style-type: none"> Check bearing assemblies for looseness. Moderately repack with lithium-soap-based grease. 			√			Repack.	
10	Drive chain	<ul style="list-style-type: none"> Check chain slack, alignment and condition. Adjust and lubricate chain with a special O-ring chain lubricant thoroughly. 	Every 500 mi (800 km) and after washing the motorcycle or riding in the rain						
11	* Steering bearings	<ul style="list-style-type: none"> Check bearing assemblies for looseness. Moderately repack with lithium-soap-based grease every 16000 mi (25000 km) or 24 months. 	√	√	√	√	Repack.	√	
12	* Steering damper	<ul style="list-style-type: none"> Check operation and for oil leakage. 		√	√	√	√	√	
13	* Chassis fasteners	<ul style="list-style-type: none"> Check all chassis fitting and fasteners. Correct if necessary. 		√	√	√	√	√	
14	Brake and clutch lever pivot shafts	<ul style="list-style-type: none"> Apply lithium-soap-based grease (all-purpose grease) lightly. 		√	√	√	√	√	
15	Shift pedal rod pivots	<ul style="list-style-type: none"> Apply lithium-soap-based grease (all-purpose grease) lightly. 		√	√	√	√	√	
16	Sidestand pivot	<ul style="list-style-type: none"> Check operation. Apply lithium-soap-based grease (all-purpose grease) lightly. 		√	√	√	√	√	

PERIODIC MAINTENANCE AND MINOR REPAIR

No.	ITEM	ROUTINE	INITIAL	ODOMETER READINGS				
			600 mi (1000 km) or 1 month	4000 mi (7000 km) or 6 months	8000 mi (13000 km) or 12 months	12000 mi (19000 km) or 18 months	16000 mi (25000 km) or 24 months	20000 mi (31000 km) or 30 months
17	* Sidestand switch	<ul style="list-style-type: none"> Check operation and replace if necessary. 	√	√	√	√	√	√
18	* Front fork	<ul style="list-style-type: none"> Check operation and for oil leakage. Replace if necessary. 		√	√	√	√	√
19	* Shock absorber assembly	<ul style="list-style-type: none"> Check operation and for oil leakage. Replace if necessary. 		√	√	√	√	√
20	* Rear suspension link pivots	<ul style="list-style-type: none"> Check operation. Correct if necessary. 			√		√	
21	Engine oil	<ul style="list-style-type: none"> Change (warm engine before draining). 	√	√	√	√	√	√
22	* Engine oil filter cartridge	<ul style="list-style-type: none"> Replace. 	√		√		√	
23	* Cooling system	<ul style="list-style-type: none"> Check hoses for cracks or damage. Replace if necessary. 		√	√	√	√	√
		<ul style="list-style-type: none"> Change with ethylene glycol anti-freeze coolant every 24 months. 					Change.	
24	* EXUP system	<ul style="list-style-type: none"> Check operation, cable free play and pulley position. 	√	Every 12000 mi (19000 km)				
25	* Front and rear brake switches	<ul style="list-style-type: none"> Check operation. 	√	√	√	√	√	√
26	* Control cables	<ul style="list-style-type: none"> Apply Yamaha chain and cable lube or engine oil SAE 10W-30 thoroughly. 	√	√	√	√	√	√

PERIODIC MAINTENANCE AND MINOR REPAIR

No.	ITEM	ROUTINE	INITIAL	ODOMETER READINGS					
			600 mi (1000 km) or 1 month	4000 mi (7000 km) or 6 months	8000 mi (13000 km) or 12 months	12000 mi (19000 km) or 18 months	16000 mi (25000 km) or 24 months	20000 mi (31000 km) or 30 months	
27	*	Throttle grip housing and cable	<ul style="list-style-type: none"> • Check operation and free play. • Adjust the throttle cable free play if necessary. • Lubricate the throttle grip housing and cable. 		√	√	√	√	√
28	*	Lights, signals and switches	<ul style="list-style-type: none"> • Check operation. • Adjust headlight beam. 	√	√	√	√	√	√

* Since these items require special tools, data and technical skills, have a Yamaha dealer perform the service.

NOTE: _____
 From 24000 mi (37000 km) or 36 months, repeat the maintenance intervals starting from 8000 mi (13000 km) or 12 months.

NOTE: _____

- Air filter
 - This model's air filter is equipped with a disposable oil-coated paper element, which must not be cleaned with compressed air to avoid damaging it.
 - The air filter element needs to be replaced more frequently when riding in unusually wet or dusty areas.
- Hydraulic brake service
 - After disassembling the brake master cylinders and calipers, always change the fluid. Regularly check the brake fluid levels and fill the reservoirs as required.
 - Every two years replace the internal components of the brake master cylinders and calipers, and change the brake fluid.

PERIODIC MAINTENANCE AND MINOR REPAIR

- Replace the brake hoses every four years and if cracked or damaged.
-

PERIODIC MAINTENANCE AND MINOR REPAIR

Removing and installing cowlings and panels

EAU18712

The cowlings and panels shown need to be removed to perform some of the maintenance jobs described in this chapter. Refer to this section each time a cawling or panel needs to be removed and installed.

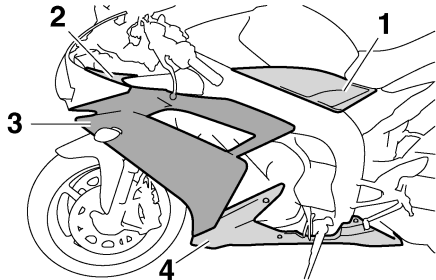

1. Panel A
2. Panel C
3. Cowling A
4. Cowling C

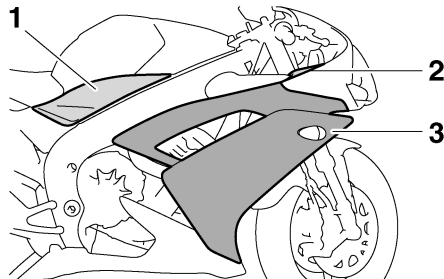

1. Panel B
2. Panel D
3. Cowling B

Cowlings A and B

EAU42970

To remove one of the cowlings

1. Remove the quick fastener screws and the quick fasteners, slide the cawling backward, and then take it off.

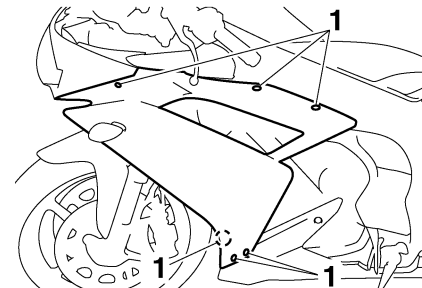

1. Quick fastener screw

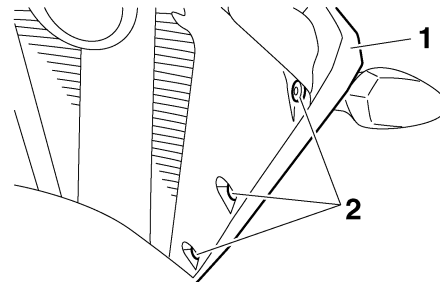

1. Cowling A
2. Quick fastener

PERIODIC MAINTENANCE AND MINOR REPAIR

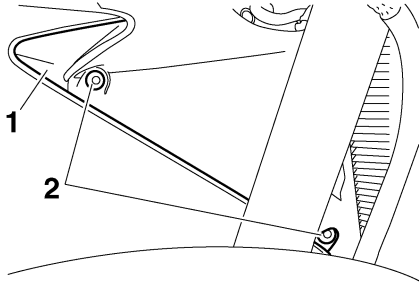

1. Cowling B
2. Quick fastener

2. Disconnect the turn signal light lead coupler.

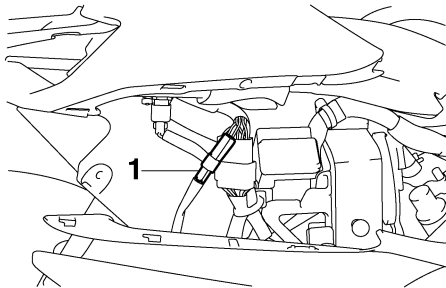

1. Turn signal light lead coupler

To install the cowling

1. Connect the turn signal light lead coupler.

2. Fit the projections on the cowling into the slots and slide it forward.

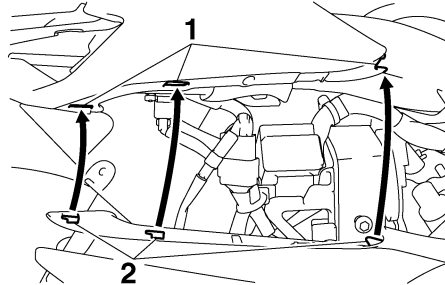

1. Slot
2. Projection

3. Install the quick fasteners and the quick fastener screws.

Cowling C

EAU42951

To remove the cowling

1. Remove cowling A. (See page 6-9.)
2. Remove the bolts and the quick fastener screws.

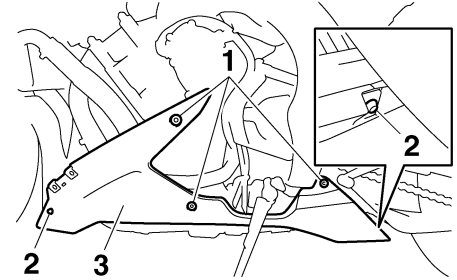

1. Bolt
2. Quick fastener screw
3. Cowling C

3. Slide the cowling backward to unhook its projections from the slots, and then pull the cowling off.

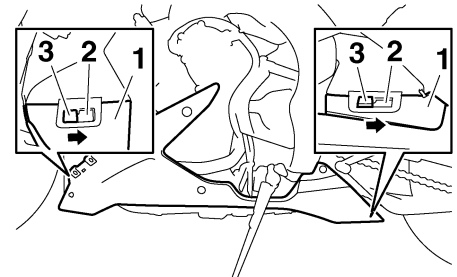

1. Cowling C
2. Slot
3. Projection

PERIODIC MAINTENANCE AND MINOR REPAIR

EAU36630

To install the cowling

1. Insert the projections into the slots, and then slide the cowling forward.

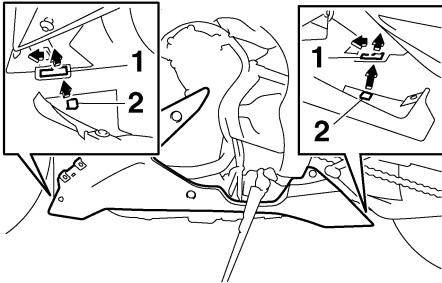

1. Slot
2. Projection

2. Place the cowling in its original position, and then install the quick fastener screws and the bolts.
3. Install cowling A.

Panels A and B

EAU33990

To remove one of the panels

1. Remove the rider seat. (See page 3-15.)
2. Remove the screw, and then remove the panel as shown.

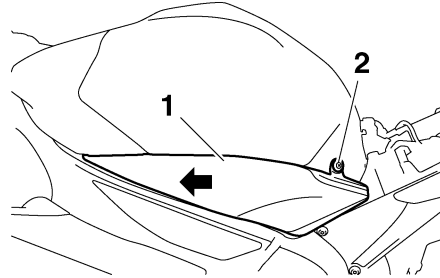

1. Panel A
2. Screw

To install the panel

1. Place the panel in its original position, and then install the screw.

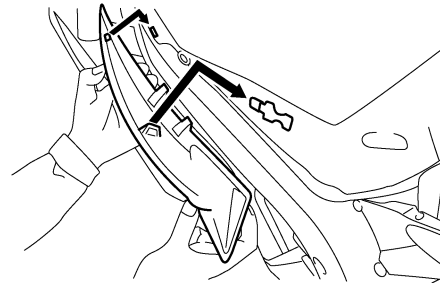

2. Install the rider seat.

Panels C and D

To remove one of the panels

Remove the screw and the quick fastener, and then pull the panel off as shown.

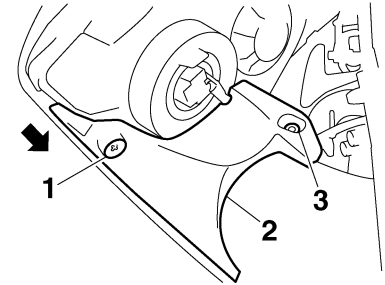

1. Screw
2. Panel C
3. Quick fastener

To install the panel

Place the panel in the original position, and then install the screw and the quick fastener.

PERIODIC MAINTENANCE AND MINOR REPAIR

6

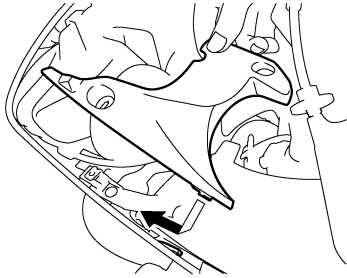

EAU19652

Checking the spark plugs

The spark plugs are important engine components, which should be checked periodically, preferably by a Yamaha dealer. Since heat and deposits will cause any spark plug to slowly erode, they should be removed and checked in accordance with the periodic maintenance and lubrication chart. In addition, the condition of the spark plugs can reveal the condition of the engine.

The porcelain insulator around the center electrode of each spark plug should be a medium-to-light tan (the ideal color when the vehicle is ridden normally), and all spark plugs installed in the engine should have the same color. If any spark plug shows a distinctly different color, the engine could be operating improperly. Do not attempt to diagnose such problems yourself. Instead, have a Yamaha dealer check the vehicle.

If a spark plug shows signs of electrode erosion and excessive carbon or other deposits, it should be replaced.

Specified spark plug:
NGK/CR9EK

Before installing a spark plug, the spark plug gap should be measured with a wire thickness gauge and, if necessary, adjusted to specification.

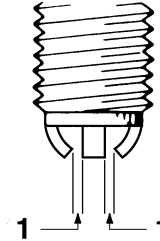

1. Spark plug gap

Spark plug gap:
0.6–0.7 mm (0.024–0.028 in)

Clean the surface of the spark plug gasket and its mating surface, and then wipe off any grime from the spark plug threads.

Tightening torque:
Spark plug:
12.5 Nm (1.25 m·kgf, 9.0 ft·lbf)

PERIODIC MAINTENANCE AND MINOR REPAIR

NOTE: _____

If a torque wrench is not available when installing a spark plug, a good estimate of the correct torque is 1/4–1/2 turn past finger tight. However, the spark plug should be tightened to the specified torque as soon as possible.

ECA10840

CAUTION: _____

Do not use any tools to remove or install the spark plug cap, otherwise the ignition coil coupler may get damaged. The spark plug cap may be difficult to remove because the rubber seal on the end of the cap fits tightly. To remove the spark plug cap, simply twist it back and forth while pulling it out; to install it, twist it back and forth while pushing it in.

Canister (for California only)

EAU19681

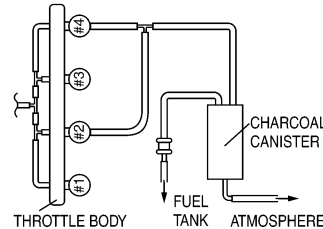

This model is equipped with a canister to prevent the discharging of fuel vapor into the atmosphere. Before operating this vehicle, make sure to check the following:

- Check each hose connection.
- Check each hose and canister for cracks or damage. Replace if damaged.
- Make sure that the canister breather is not blocked, and if necessary, clean it.

Engine oil and oil filter cartridge

EAU19911

The engine oil level should be checked before each ride. In addition, the oil must be changed and the oil filter cartridge replaced at the intervals specified in the periodic maintenance and lubrication chart.

To check the engine oil level

1. Place the vehicle on a level surface and hold it in an upright position.

NOTE: _____

Make sure that the vehicle is positioned straight up when checking the oil level. A slight tilt to the side can result in a false reading.

2. Start the engine, warm it up for several minutes, and then turn it off.
3. Wait a few minutes until the oil settles, and then check the oil level through the check window located at the bottom-right side of the crankcase.

PERIODIC MAINTENANCE AND MINOR REPAIR

NOTE:

The engine oil should be between the minimum and maximum level marks.

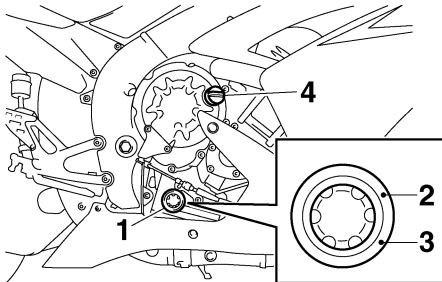

1. Engine oil level check window
2. Maximum level mark
3. Minimum level mark
4. Engine oil filler cap

4. If the engine oil is at or below the minimum level mark, add sufficient oil of the recommended type to raise it to the correct level.

To change the engine oil (with or without oil filter cartridge replacement)

1. Remove cowling C. (See page 6-9.)

2. Start the engine, warm it up for several minutes, and then turn it off.
3. Place an oil pan under the engine to collect the used oil.
4. Remove the engine oil filler cap and drain bolt to drain the oil from the crankcase.

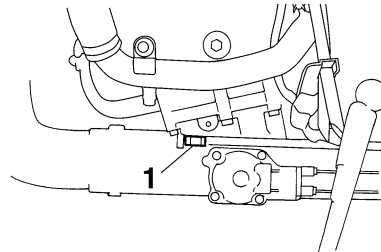

1. Engine oil drain bolt

NOTE:

Skip steps 5–7 if the oil filter cartridge is not being replaced.

5. Remove the oil filter cartridge with an oil filter wrench.

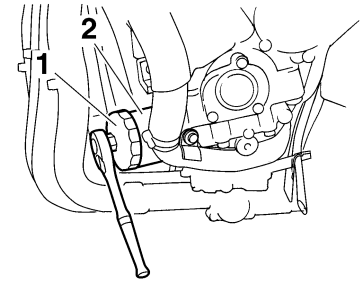

1. Oil filter wrench
2. Engine oil filter cartridge

NOTE:

An oil filter wrench is available at a Yamaha dealer.

6. Apply a thin coat of engine oil to the O-ring of the new oil filter cartridge.

PERIODIC MAINTENANCE AND MINOR REPAIR

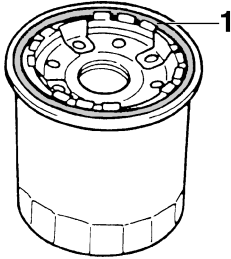

1. O-ring

NOTE: _____

Make sure that the O-ring is properly seated.

7. Install the new oil filter cartridge with an oil filter wrench, and then tighten it to the specified torque with a torque wrench.

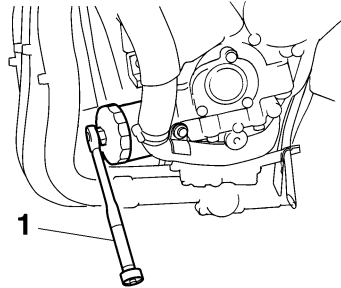

1. Torque wrench

Tightening torque:

Oil filter cartridge:
17 Nm (1.7 m·kgf, 12 ft·lbf)

8. Install the engine oil drain bolt, and then tighten it to the specified torque.

NOTE: _____

Check the washer for damage and replace it if necessary.

Tightening torque:

Engine oil drain bolt:
43 Nm (4.3 m·kgf, 31 ft·lbf)

9. Add the specified amount of the recommended engine oil, and then install and tighten the oil filler cap.

Recommended engine oil:

See page 8-1.

Oil quantity:

Without oil filter cartridge replacement:

2.90 L (3.07 US qt) (2.55 Imp.qt)

With oil filter cartridge replacement:

3.10 L (3.28 US qt) (2.73 Imp.qt)

ECA11620

CAUTION: _____

- In order to prevent clutch slippage (since the engine oil also lubricates the clutch), do not mix any chemical additives. Do not use oils with a diesel specification of “CD” or oils of a higher quality than specified. In addition, do not use oils labeled “ENERGY CONSERVING II” or higher.
- Make sure that no foreign material enters the crankcase.

10. Start the engine, and then let it idle for several minutes while checking it for oil leakage. If oil is leaking, immediately turn the engine off and check for the cause.

PERIODIC MAINTENANCE AND MINOR REPAIR

NOTE: _____

After the engine is started, the engine oil level warning light should go off if the oil level is sufficient.

ECA10400

CAUTION: _____

If the oil level warning light flickers or remains on, immediately turn the engine off and have a Yamaha dealer check the vehicle.

11. Turn the engine off, and then check the oil level and correct it if necessary.
12. Install the cowling.

6

Coolant

EAU20070

The coolant level should be checked before each ride. In addition, the coolant must be changed at the intervals specified in the periodic maintenance and lubrication chart.

To check the coolant level

EAU42990

1. Place the vehicle on a level surface and hold it in an upright position.

NOTE: _____

- The coolant level must be checked on a cold engine since the level varies with engine temperature.
- Make sure that the vehicle is positioned straight up when checking the coolant level. A slight tilt to the side can result in a false reading.

2. Check the coolant level in the coolant reservoir.

NOTE: _____

The coolant should be between the minimum and maximum level marks.

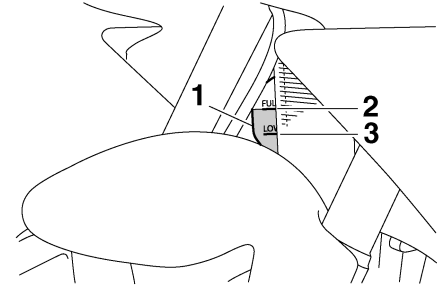

1. Coolant reservoir
2. Maximum level mark
3. Minimum level mark

3. If the coolant is at or below the minimum level mark, remove cowl- ing B. (See page 6-9.)
4. Remove the reservoir cap, add coolant to the maximum level mark, and then install the reservoir cap.

PERIODIC MAINTENANCE AND MINOR REPAIR

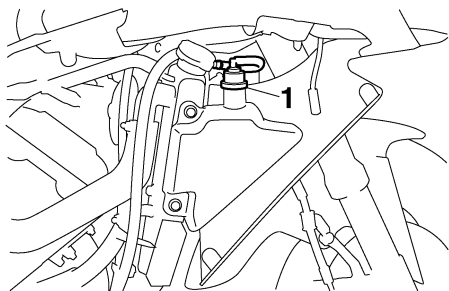

1. Coolant reservoir cap

Coolant reservoir capacity (up to the maximum level mark):

0.25 L (0.26 US qt) (0.22 Imp.qt)

ECA10471

CAUTION:

- If coolant is not available, use distilled water or soft tap water instead. Do not use hard water or salt water since it is harmful to the engine.
- If water has been used instead of coolant, replace it with coolant as soon as possible, otherwise the cooling system will not be protected against frost and corrosion.

- If water has been added to the coolant, have a Yamaha dealer check the antifreeze content of the coolant as soon as possible, otherwise the effectiveness of the coolant will be reduced.

EWA10380

! WARNING

Never attempt to remove the radiator cap when the engine is hot.

5. Install the cowlings.

NOTE:

- The radiator fans are automatically switched on or off according to the coolant temperature in the radiator.
- If the engine overheats, see page 6-47 for further instructions.

EAU42980

To change the coolant

1. Place the vehicle on a level surface and let the engine cool if necessary.
2. Remove cowlings B and C. (See page 6-9.)

3. Place a container under the engine to collect the used coolant.
4. Remove the radiator cap.

EWA10380

! WARNING

Never attempt to remove the radiator cap when the engine is hot.

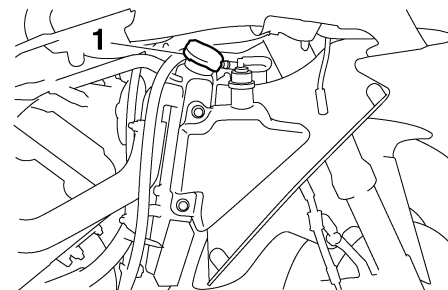

1. Radiator cap

5. Remove the coolant drain bolt to drain the cooling system.

PERIODIC MAINTENANCE AND MINOR REPAIR

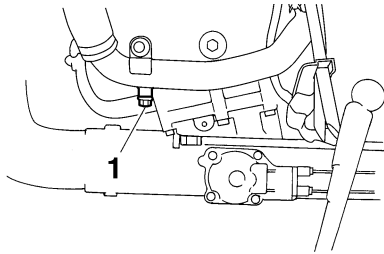

1. Coolant drain bolt

6. Remove the coolant reservoir cap.
7. Remove the coolant reservoir by removing the bolts, and then turn the reservoir upside down to empty it.

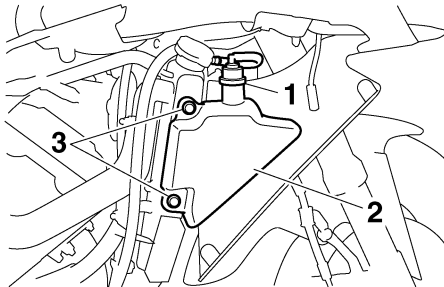

1. Coolant reservoir cap
2. Coolant reservoir
3. Bolt

8. After the coolant is completely drained, thoroughly flush the cooling system with clean tap water.
9. Install the coolant reservoir by installing the bolts.
10. Install the coolant drain bolt, and then tighten it to the specified torque.

NOTE: _____
Check the washer for damage and replace it if necessary.

Tightening torque:

Coolant drain bolt:
7.0 Nm (0.7 m·kgf, 5.1 ft·lbf)

11. Pour the recommended coolant into the reservoir to the maximum level mark, and then install the coolant reservoir cap.
12. Pour the recommended coolant into the radiator until it is full.

Antifreeze/water mixture ratio:

1:1

Recommended antifreeze:

High-quality ethylene glycol antifreeze containing corrosion inhibitors for aluminum engines

Coolant quantity:

Radiator capacity (including all routes):

2.76 L (2.92 US qt) (2.43 Imp.qt)

Coolant reservoir capacity (up to the maximum level mark):

0.25 L (0.26 US qt) (0.22 Imp.qt)

ECA10471

CAUTION:

- If coolant is not available, use distilled water or soft tap water instead. Do not use hard water or salt water since it is harmful to the engine.
- If water has been used instead of coolant, replace it with coolant as soon as possible, otherwise the cooling system will not be protected against frost and corrosion.
- If water has been added to the coolant, have a Yamaha dealer check the antifreeze content of

PERIODIC MAINTENANCE AND MINOR REPAIR

the coolant as soon as possible, otherwise the effectiveness of the coolant will be reduced.

13. Install the radiator cap, start the engine, let it idle for several minutes, and then turn it off.
14. Remove the radiator cap to check the coolant level in the radiator. If necessary, add sufficient coolant until it reaches the top of the radiator, and then install the radiator cap.
15. Start the engine, and then check the vehicle for coolant leakage. If coolant is leaking, have a Yamaha dealer check the cooling system.
16. Install the cowlings.

Replacing the air filter element EAU42960

The air filter element should be replaced at the intervals specified in the periodic maintenance and lubrication chart. Replace the air filter element more frequently if you are riding in unusually wet or dusty areas.

1. Remove the rider seat. (See page 3-15.)
2. Remove panels A and B. (See page 6-9.)
3. Remove the fuel tank bolts.

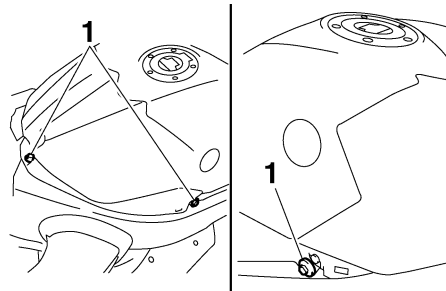

1. Bolt

4. Lift the front of the fuel tank, and then tilt it back and away from the air filter case. (Do not disconnect the fuel hoses!)

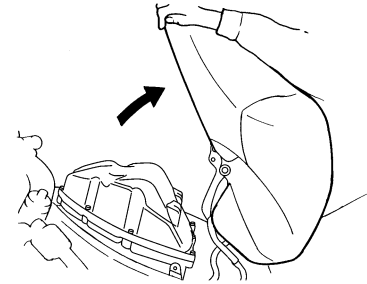

EWA10410

WARNING

- Make sure that the fuel tank is well supported.
- Do not tilt or pull the fuel tank too much, otherwise the fuel hoses may come loose, which could cause fuel leakage.

5. Remove the air filter case cover by removing the screws.

PERIODIC MAINTENANCE AND MINOR REPAIR

ECA10480

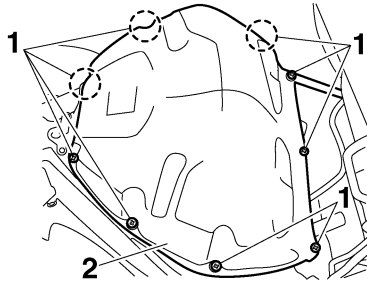

1. Screw
2. Air filter case cover

ECA12880

CAUTION:

When removing the air filter case cover, be careful not to allow foreign objects to drop into the air intake manifold.

6. Pull the air filter element out.

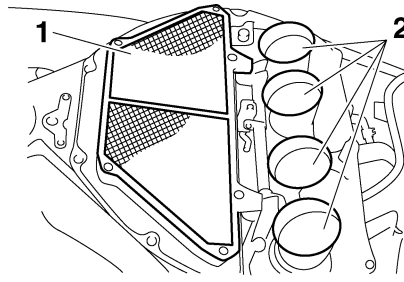

1. Air filter element
2. Air intake manifold

7. Install a new air filter element by fitting the projections on the element into the slots in the air filter case.

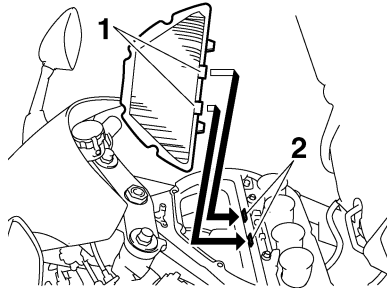

1. Projection
2. Slot

CAUTION:

- Make sure that the air filter element is properly seated in the air filter case.
- The engine should never be operated without the air filter element installed, otherwise the piston(s) and/or cylinder(s) may become excessively worn.

8. Install the air filter case cover by installing the screws.
9. Place the fuel tank in its original position, and then install the bolts.

EWA12380

WARNING

- Before installing the fuel tank, make sure that the fuel hoses are not damaged. If any fuel hose is damaged, do not start the engine. Have a Yamaha dealer replace the hose, otherwise fuel may leak.
- Make sure that the fuel hoses are properly connected and routed, and are not pinched.

PERIODIC MAINTENANCE AND MINOR REPAIR

- Be sure to place the fuel tank breather/overflow hose in its original position.

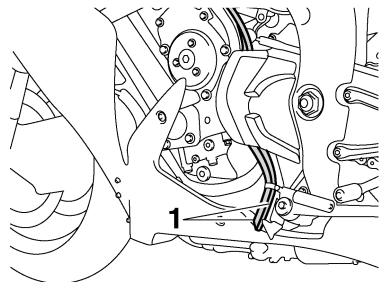

1. Fuel tank breather/overflow hose
10. Install the panels.
11. Install the rider seat.

Checking the throttle cable free play

EAU21382

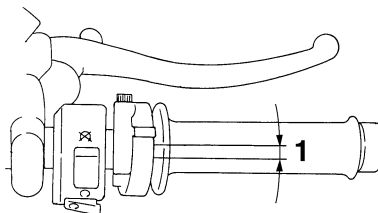

1. Throttle cable free play

The throttle cable free play should measure 3.0–5.0 mm (0.12–0.20 in) at the throttle grip. Periodically check the throttle cable free play and, if necessary, have a Yamaha dealer adjust it.

Valve clearance

EAU21401

The valve clearance changes with use, resulting in improper air-fuel mixture and/or engine noise. To prevent this from occurring, the valve clearance must be adjusted by a Yamaha dealer at the intervals specified in the periodic maintenance and lubrication chart.

PERIODIC MAINTENANCE AND MINOR REPAIR

Tires

EAU21750

To maximize the performance, durability, and safe operation of your motor-cycle, note the following points regarding the specified tires.

Tire air pressure

The tire air pressure should be checked and, if necessary, adjusted before each ride.

EWA10500

WARNING

- The tire air pressure must be checked and adjusted on cold tires (i.e., when the temperature of the tires equals the ambient temperature).
- The tire air pressure must be adjusted in accordance with the riding speed and with the total weight of rider, passenger, cargo, and accessories approved for this model.

Tire air pressure (measured on cold tires):

0–90 kg (0–198 lb):

Front:

250 kPa (36 psi) (2.50 kgf/cm²)

Rear:

290 kPa (42 psi) (2.90 kgf/cm²)

90–195 kg (198–430 lb):

Front:

250 kPa (36 psi) (2.50 kgf/cm²)

Rear:

290 kPa (42 psi) (2.90 kgf/cm²)

High-speed riding:

Front:

250 kPa (36 psi) (2.50 kgf/cm²)

Rear:

290 kPa (42 psi) (2.90 kgf/cm²)

Maximum load*:

195 kg (430 lb)

* Total weight of rider, passenger, cargo and accessories

EWA10510

WARNING

Proper loading of your vehicle is important for several characteristics of your vehicle, such as handling, braking, performance and safety. Do not carry loosely packed items that can shift. Securely pack your heaviest items close to the center of the vehicle, and distribute the weight

evenly from side to side. Properly adjust the suspension for your load, and check the condition and pressure of your tires. **NEVER OVERLOAD YOUR VEHICLE.** Make sure that the total weight of the cargo, rider, passenger, and accessories (cowling, saddlebags, etc. if approved for this model) does not exceed the maximum load of the vehicle. Operation of an overloaded vehicle could cause tire damage, an accident, or even injury.

Tire inspection

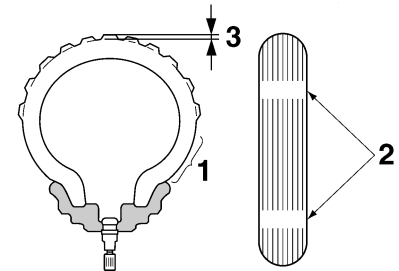

1. Tire sidewall
2. Tire wear indicator
3. Tire tread depth

PERIODIC MAINTENANCE AND MINOR REPAIR

Always check the tires before operating the motorcycle. If a tire tread shows crosswise lines (minimum tread depth), if the tire has a nail or glass fragments in it, or if the sidewall is cracked, contact a Yamaha dealer immediately and have the tire replaced.

Minimum tire tread depth (front and rear):
1.0 mm (0.04 in)

EWA10580

WARNING

- It is dangerous to ride with a worn-out tire. When a tire tread begins to show crosswise lines, have a Yamaha dealer replace the tire immediately.
- The replacement of all wheel- and brake-related parts, including the tires, should be left to a Yamaha dealer, who has the necessary professional knowledge and experience.

Tire information

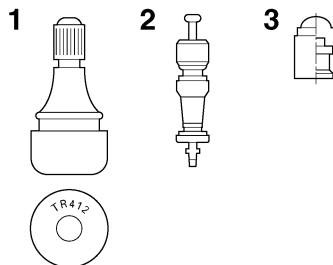

1. Tire air valve
2. Tire air valve core
3. Tire air valve cap with seal

This motorcycle is equipped with cast wheels and tubeless tires with valves.

EWA10480

WARNING

- The front and rear tires should be of the same make and design, otherwise the handling characteristics of the motorcycle cannot be guaranteed.
- After extensive tests, only the tires listed below have been approved for this model by Yamaha Motor Co., Ltd.

- Always make sure that the valve caps are securely installed to prevent air pressure leakage.
- Use only the tire valves and valve cores listed below to avoid tire deflation during a high-speed ride.

Front tire:

Size:

120/70 ZR17M/C (58W)

Manufacturer/model:

PIRELLI/DIABLO CORSA E
MICHELIN/Pilot POWER P

Rear tire:

Size:

190/50 ZR17M/C (73W)

Manufacturer/model:

PIRELLI/DIABLO CORSA L
MICHELIN/Pilot POWER

FRONT and REAR:

Tire air valve:

TR412

Valve core:

#9100 (original)

PERIODIC MAINTENANCE AND MINOR REPAIR

EWA10600

WARNING

This motorcycle is fitted with super-high-speed tires. Note the following points in order to make the most efficient use of these tires.

- Use only the specified replacement tires. Other tires may run the danger of bursting at super high speeds.
- Brand-new tires can have a relatively poor grip on certain road surfaces until they have been “broken in”. Therefore, it is advisable before doing any high-speed riding to ride conservatively for approximately 100 km (60 mi) after installing a new tire.
- The tires must be warmed up before a high-speed run.
- Always adjust the tire air pressure according to the operating conditions.

EAU21960

Cast wheels

To maximize the performance, durability, and safe operation of your vehicle, note the following points regarding the specified wheels.

- The wheel rims should be checked for cracks, bends or warpage before each ride. If any damage is found, have a Yamaha dealer replace the wheel. Do not attempt even the smallest repair to the wheel. A deformed or cracked wheel must be replaced.
- The wheel should be balanced whenever either the tire or wheel has been changed or replaced. An unbalanced wheel can result in poor performance, adverse handling characteristics, and a shortened tire life.
- Ride at moderate speeds after changing a tire since the tire surface must first be “broken in” for it to develop its optimal characteristics.

EAU22011

Accessories and replacement parts

EWA10621

WARNING

This vehicle is not designed to pull a trailer or to be attached to a sidecar. The accessories or replacement parts you choose for your vehicle should be designed specifically for this model, and they must be securely mounted to maintain the inherent stability of the original design. Genuine Yamaha Parts and Accessories are designed and tested to be compatible with your vehicle. Please consider Genuine Yamaha Parts and Accessories before making a purchase. Use of non-Yamaha-approved accessories or replacement parts may cause loss of handling stability and riding safety. Since Yamaha cannot control the quality of accessories or parts manufactured by other companies, Yamaha cannot be held liable for

PERIODIC MAINTENANCE AND MINOR REPAIR

any consequences caused by the use of items which have not been approved by Yamaha.

Adjusting the clutch lever free play

EAU33890

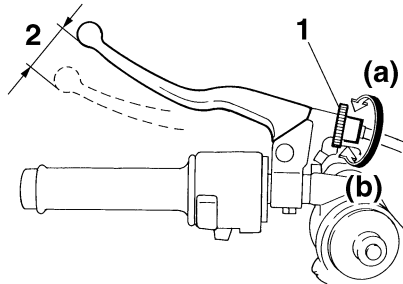

1. Clutch lever free play adjusting bolt
2. Clutch lever free play

The clutch lever free play should measure 10.0–15.0 mm (0.39–0.59 in) as shown. Periodically check the clutch lever free play and, if necessary, adjust it as follows.

To increase the clutch lever free play, turn the adjusting bolt at the clutch lever in direction (a). To decrease the clutch lever free play, turn the adjusting bolt in direction (b).

NOTE: _____
If the specified clutch lever free play cannot be obtained as described above, proceed as follows.

1. Fully turn the adjusting bolt at the clutch lever in direction (a) to loosen the clutch cable.
2. Loosen the locknut at the crankcase.
3. To increase the clutch lever free play, turn the adjusting nut in direction (a). To decrease the clutch lever free play, turn the adjusting nut in direction (b).

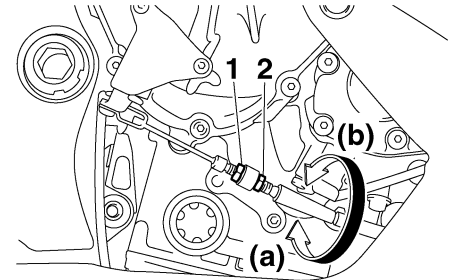

1. Locknut
2. Clutch lever free play adjusting nut (crankcase)
4. Tighten the locknut.

PERIODIC MAINTENANCE AND MINOR REPAIR

Adjusting the rear brake light switch

EAU22270

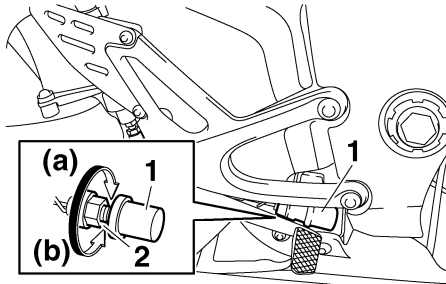

1. Rear brake light switch
2. Rear brake light switch adjusting nut

6

The rear brake light switch, which is activated by the brake pedal, is properly adjusted when the brake light comes on just before braking takes effect. If necessary, adjust the brake light switch as follows.

Turn the adjusting nut while holding the rear brake light switch in place. To make the brake light come on earlier, turn the adjusting nut in direction (a). To make the brake light come on later, turn the adjusting nut in direction (b).

Checking the front and rear brake pads

EAU22390

The front and rear brake pads must be checked for wear at the intervals specified in the periodic maintenance and lubrication chart.

Front brake pads

EAU43062

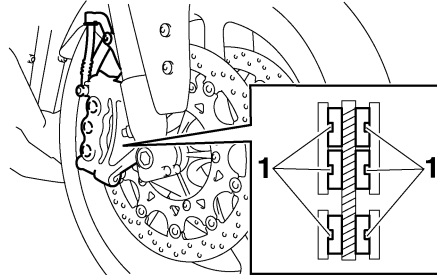

1. Brake pad wear indicator groove

The front brake calipers are equipped with two sets of brake pads.

Each front brake pad is provided with one or two wear indicator grooves, which allow you to check the brake pad wear without having to disassemble the brake. To check the brake pad wear, check the wear indicator grooves. If a brake pad has worn to the point that a

wear indicator groove almost appears, have a Yamaha dealer replace the brake pads as a set.

Rear brake pads

EAU22500

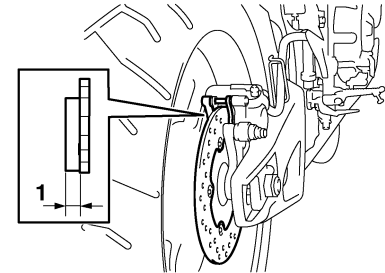

1. Lining thickness

Check each rear brake pad for damage and measure the lining thickness. If a brake pad is damaged or if the lining thickness is less than 1.0 mm (0.04 in), have a Yamaha dealer replace the brake pads as a set.

PERIODIC MAINTENANCE AND MINOR REPAIR

Checking the brake fluid level EAU22580

Front brake

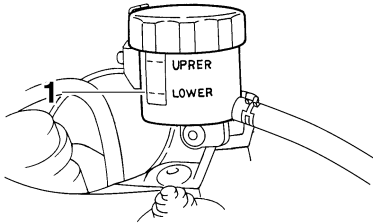

1. Minimum level mark

Rear brake

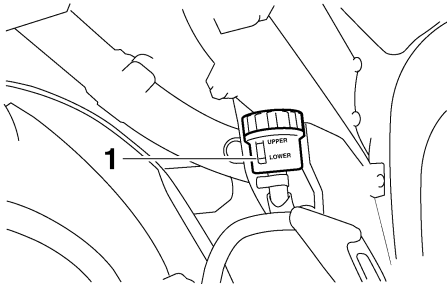

1. Minimum level mark

Insufficient brake fluid may allow air to enter the brake system, possibly causing it to become ineffective.

Before riding, check that the brake fluid is above the minimum level mark and replenish if necessary. A low brake fluid level may indicate worn brake pads and/or brake system leakage. If the brake fluid level is low, be sure to check the brake pads for wear and the brake system for leakage.

Observe these precautions:

- When checking the fluid level, make sure that the top of the brake fluid reservoir is level.
- Use only the recommended quality brake fluid, otherwise the rubber seals may deteriorate, causing leakage and poor braking performance.

Recommended brake fluid:

DOT 4

- Refill with the same type of brake fluid. Mixing fluids may result in a harmful chemical reaction and lead to poor braking performance.

- Be careful that water does not enter the brake fluid reservoir when refilling. Water will significantly lower the boiling point of the fluid and may result in vapor lock.
- Brake fluid may deteriorate painted surfaces or plastic parts. Always clean up spilled fluid immediately.
- As the brake pads wear, it is normal for the brake fluid level to gradually go down. However, if the brake fluid level goes down suddenly, have a Yamaha dealer check the cause.

PERIODIC MAINTENANCE AND MINOR REPAIR

Changing the brake fluid

EAU22730

Have a Yamaha dealer change the brake fluid at the intervals specified in the NOTE after the periodic maintenance and lubrication chart. In addition, have the oil seals of the master cylinders and calipers as well as the brake hoses replaced at the intervals listed below or whenever they are damaged or leaking.

- Oil seals: Replace every two years.
- Brake hoses: Replace every four years.

Drive chain slack

EAU22760

The drive chain slack should be checked before each ride and adjusted if necessary.

To check the drive chain slack

EAU22772

1. Place the motorcycle on the side-stand.

NOTE: _____

When checking and adjusting the drive chain slack, there should be no weight on the motorcycle.

2. Shift the transmission into the neutral position.
3. Move the rear wheel by pushing the motorcycle to locate the tightest portion of the drive chain, and then measure the drive chain slack as shown.

Drive chain slack:

30.0–40.0 mm (1.18–1.57 in)

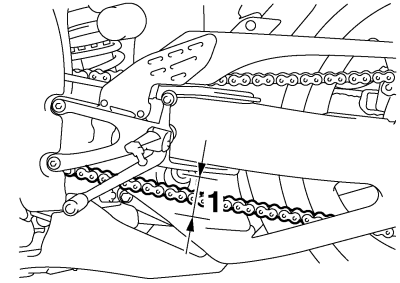

1. Drive chain slack

4. If the drive chain slack is incorrect, adjust it as follows.

To adjust the drive chain slack

EAU34311

1. Loosen the axle nut and the lock-nut on each side of the swingarm.
2. To tighten the drive chain, turn the adjusting bolt on each side of the swingarm in direction (a). To loosen the drive chain, turn the adjusting bolt on each side of the swingarm in direction (b), and then push the rear wheel forward.

PERIODIC MAINTENANCE AND MINOR REPAIR

NOTE: _____

Using the alignment marks on each side of the swingarm, make sure that both chain pullers are in the same position for proper wheel alignment.

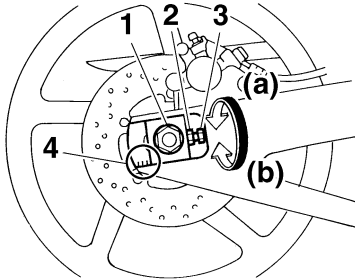

1. Axle nut
2. Drive chain slack adjusting bolt
3. Locknut
4. Alignment marks

ECA10570

CAUTION: _____

Improper drive chain slack will overload the engine as well as other vital parts of the motorcycle and can lead to chain slippage or breakage. To prevent this from occurring, keep the drive chain slack within the specified limits.

3. Tighten the locknuts, then the axle nut to their specified torques.

Tightening torques:

Locknut:

16 Nm (1.6 m-kgf, 11 ft-lbf)

Axle nut:

150 Nm (15.0 m-kgf, 110 ft-lbf)

EAU23022

Cleaning and lubricating the drive chain

The drive chain must be cleaned and lubricated at the intervals specified in the periodic maintenance and lubrication chart, otherwise it will quickly wear out, especially when riding in dusty or wet areas. Service the drive chain as follows.

ECA10581

CAUTION: _____

The drive chain must be lubricated after washing the motorcycle and riding in the rain.

1. Clean the drive chain with kerosene and a small soft brush.

ECA11120

CAUTION: _____

To prevent damaging the O-rings, do not clean the drive chain with steam cleaners, high-pressure washers or inappropriate solvents.

2. Wipe the drive chain dry.
3. Thoroughly lubricate the drive chain with a special O-ring chain lubricant.

PERIODIC MAINTENANCE AND MINOR REPAIR

CAUTION:

ECA11110

Do not use engine oil or any other lubricants for the drive chain, as they may contain substances that could damage the O-rings.

Checking and lubricating the cables

EAU23091

The operation of all control cables and the condition of the cables should be checked before each ride, and the cables and cable ends should be lubricated if necessary. If a cable is damaged or does not move smoothly, have a Yamaha dealer check or replace it.

Recommended lubricant:

Yamaha Chain and Cable Lube or engine oil SAE 10W-30

EWA10710

WARNING

Damage to the outer housing of cables may result in internal rusting and cause interference with cable movement. Replace damaged cables as soon as possible to prevent unsafe conditions.

Checking and lubricating the throttle grip and cable

EAU23111

The operation of the throttle grip should be checked before each ride. In addition, the cable should be lubricated at the intervals specified in the periodic maintenance chart.

PERIODIC MAINTENANCE AND MINOR REPAIR

Checking and lubricating the brake and clutch levers

EAU23140

Brake lever

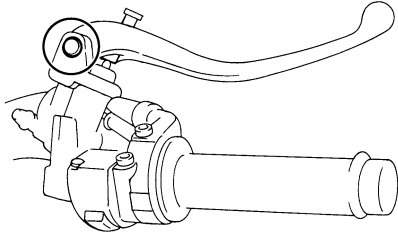

Clutch lever

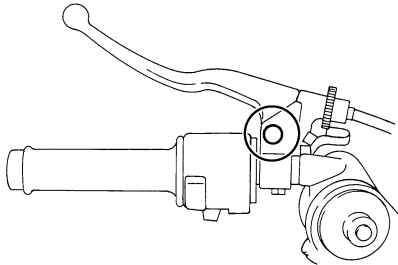

The operation of the brake and clutch levers should be checked before each ride, and the lever pivots should be lubricated if necessary.

Recommended lubricant:
Lithium-soap-based grease (all-purpose grease)

Checking and lubricating the shift pedal

EAU43070

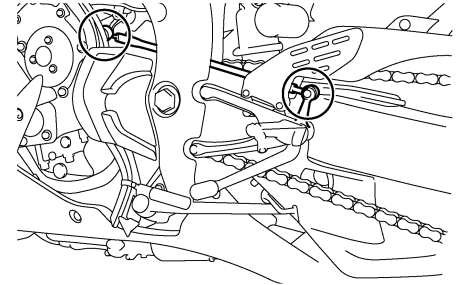

The operation of the shift pedal should be checked before each ride, and the shift pedal rod pivots should be lubricated if necessary.

Recommended lubricant:
Lithium-soap-based grease (all-purpose grease)

PERIODIC MAINTENANCE AND MINOR REPAIR

Checking and lubricating the sidestand

EAU23200

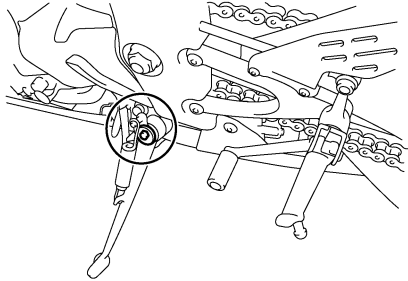

The operation of the sidestand should be checked before each ride, and the sidestand pivot and metal-to-metal contact surfaces should be lubricated if necessary.

EWA10730

⚠ WARNING

If the sidestand does not move up and down smoothly, have a Yamaha dealer check or repair it.

Recommended lubricant:

Lithium-soap-based grease (all-purpose grease)

Lubricating the swingarm pivots

EAUM1650

The swingarm pivots must be lubricated at the intervals specified in the periodic maintenance and lubrication chart.

Recommended lubricant:

Lithium-soap-based grease

Checking the front fork

EAU23271

The condition and operation of the front fork must be checked as follows at the intervals specified in the periodic maintenance and lubrication chart.

To check the condition

EWA10750

⚠ WARNING

Securely support the vehicle so that there is no danger of it falling over.

Check the inner tubes for scratches, damage and excessive oil leakage.

To check the operation

1. Place the vehicle on a level surface and hold it in an upright position.
2. While applying the front brake, push down hard on the handlebars several times to check if the front fork compresses and rebounds smoothly.

PERIODIC MAINTENANCE AND MINOR REPAIR

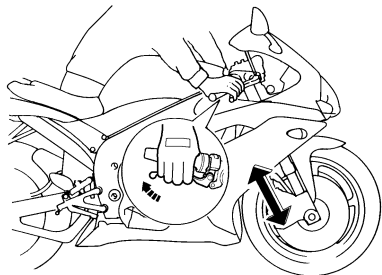

ECA10590

CAUTION:

If any damage is found or the front fork does not operate smoothly, have a Yamaha dealer check or repair it.

Checking the steering

EAU23280

Worn or loose steering bearings may cause danger. Therefore, the operation of the steering must be checked as follows at the intervals specified in the periodic maintenance and lubrication chart.

1. Place a stand under the engine to raise the front wheel off the ground.

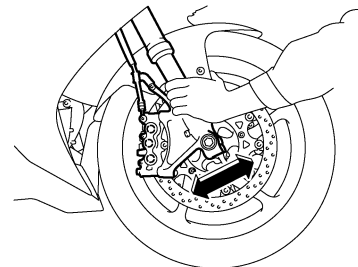

EWA10750

WARNING

Securely support the vehicle so that there is no danger of it falling over.

2. Hold the lower ends of the front fork legs and try to move them forward and backward. If any free play can be felt, have a Yamaha dealer check or repair the steering.

PERIODIC MAINTENANCE AND MINOR REPAIR

EAU23290

Checking the wheel bearings

The front and rear wheel bearings must be checked at the intervals specified in the periodic maintenance and lubrication chart. If there is play in the wheel hub or if the wheel does not turn smoothly, have a Yamaha dealer check the wheel bearings.

EAU23441

Battery

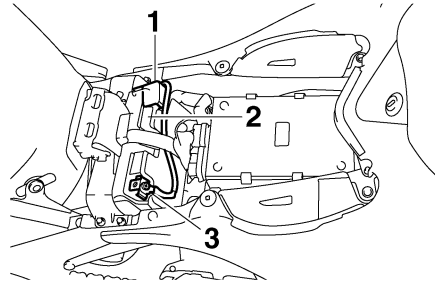

1. Positive battery terminal
2. Battery
3. Negative battery terminal

This model is equipped with a sealed-type (MF) battery, which does not require any maintenance. There is no need to check the electrolyte or to add distilled water.

To charge the battery

Have a Yamaha dealer charge the battery as soon as possible if it seems to have discharged. Keep in mind that the battery tends to discharge more quickly if the vehicle is equipped with optional electrical accessories.

EWA10760

! WARNING

- **Electrolyte is poisonous and dangerous since it contains sulfuric acid, which causes severe burns. Avoid any contact with skin, eyes or clothing and always shield your eyes when working near batteries. In case of contact, administer the following FIRST AID.**
 - **EXTERNAL:** Flush with plenty of water.
 - **INTERNAL:** Drink large quantities of water or milk and immediately call a physician.
 - **EYES:** Flush with water for 15 minutes and seek prompt medical attention.
- **Batteries produce explosive hydrogen gas. Therefore, keep sparks, flames, cigarettes, etc., away from the battery and provide sufficient ventilation when charging it in an enclosed space.**

PERIODIC MAINTENANCE AND MINOR REPAIR

- **KEEP THIS AND ALL BATTERIES OUT OF THE REACH OF CHILDREN.**

To store the battery

1. If the vehicle will not be used for more than one month, remove the battery, fully charge it, and then place it in a cool, dry place.
2. If the battery will be stored for more than two months, check it at least once a month and fully charge it if necessary.
3. Fully charge the battery before installation.
4. After installation, make sure that the battery leads are properly connected to the battery terminals.

ECA10630

CAUTION:

- **Always keep the battery charged. Storing a discharged battery can cause permanent battery damage.**
- **To charge a sealed-type (MF) battery, a special (constant-voltage) battery charger is required. Using a conventional battery**

charger will damage the battery. If you do not have access to a sealed-type (MF) battery charger, have a Yamaha dealer charge your battery.

Replacing the fuses

EAU42920

To access the main fuse

The main fuse is located under the rider seat and can be accessed as follows:

1. Remove the rider seat. (See page 3-15.)
2. Move the ECU away from the fuse.

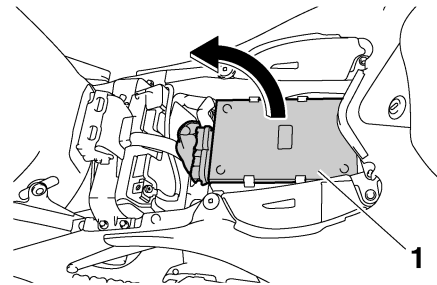

1. ECU

PERIODIC MAINTENANCE AND MINOR REPAIR

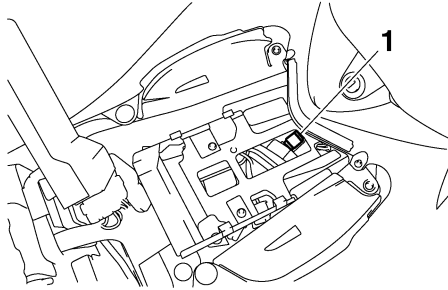

1. Main fuse

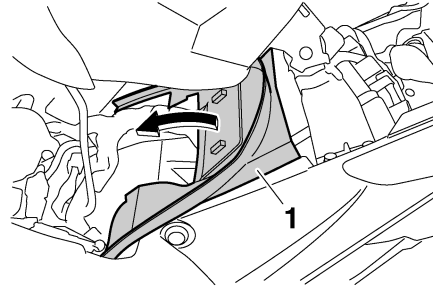

1. Rubber damper

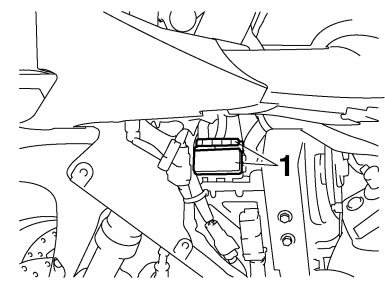

1. Fuse box

To access the fuel injection system fuse

The fuel injection system fuse is located under the fuel tank and can be accessed as follows:

1. Lift the fuel tank. (See page 6-19.)
2. Pull up the rubber damper as shown.

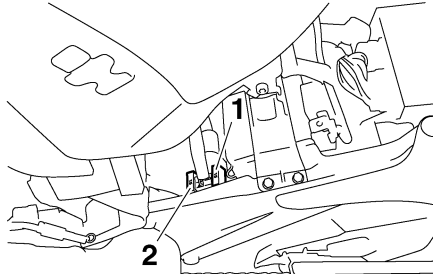

1. Fuel injection system fuse
2. Fuel injection system spare fuse

To access the fuse box

The fuse box, which contains the fuses for the individual circuits, is located behind cowl A.

To access the fuse box, remove cowl A. (See page 6-9.)

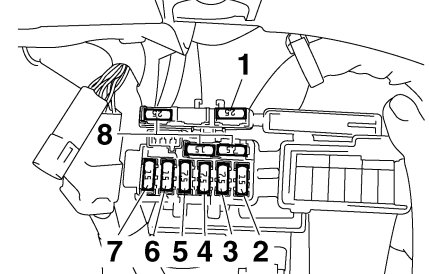

1. Headlight fuse
2. Ignition fuse
3. Signaling system fuse
4. ETV (electric throttle valve) fuse
5. Backup fuse (for odometer, clock and immobilizer system)
6. Right radiator fan fuse
7. Left radiator fan fuse
8. Spare fuse

PERIODIC MAINTENANCE AND MINOR REPAIR

To replace a fuse

If a fuse is blown, replace it as follows.

1. Turn the key to "OFF" and turn off the electrical circuit in question.
2. Remove the blown fuse, and then install a new fuse of the specified amperage.

Specified fuses:

Main fuse:

50.0 A

Headlight fuse:

25.0 A

Signaling system fuse:

7.5 A

Ignition fuse:

15.0 A

Radiator fan fuse:

15.0 A × 2

Fuel injection system fuse:

15.0 A

Backup fuse:

7.5 A

Electric throttle valve fuse:

7.5 A

CAUTION:

Do not use a fuse of a higher amperage rating than recommended to avoid causing extensive damage to the electrical system and possibly a fire.

3. Turn the key to "ON" and turn on the electrical circuit in question to check if the device operates.
4. If the fuse immediately blows again, have a Yamaha dealer check the electrical system.

ECA10640

Replacing a headlight bulb

EAU42930

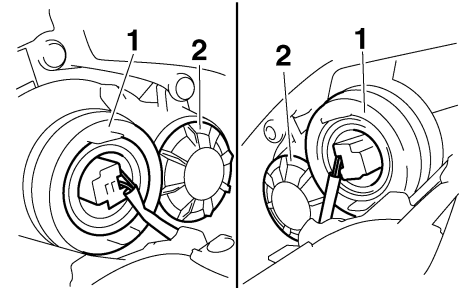

1. High beam headlight bulb
2. Low beam headlight bulb

This model is equipped with quartz bulb headlights. If a headlight bulb burns out, replace it as follows.

To replace a high beam headlight bulb

1. Remove panel C (if replacing the left headlight bulb) or panel D (if replacing the right headlight bulb). (See page 6-9.)
2. Disconnect the headlight coupler, and then remove the bulb cover.

PERIODIC MAINTENANCE AND MINOR REPAIR

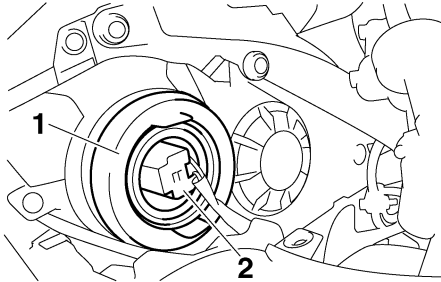

1. Headlight bulb cover
2. Headlight coupler

3. Unhook the headlight bulb holder, and then remove the defective bulb.

6

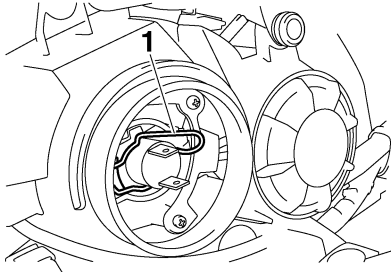

1. Headlight bulb holder

WARNING

EWA10790

Headlight bulbs get very hot. Therefore, keep flammable products away from a lit headlight bulb, and do not touch the bulb until it has cooled down.

4. Place a new headlight bulb into position, and then secure it with the bulb holder.

ECA10650

CAUTION:

Take care not to damage the following parts:

● Headlight bulb

Do not touch the glass part of the headlight bulb to keep it free from oil, otherwise the transparency of the glass, the luminosity of the bulb, and the bulb life will be adversely affected. Thoroughly clean off any dirt and fingerprints on the headlight bulb using a cloth moistened with alcohol or thinner.

● Headlight lens

Do not affix any type of tinted film or stickers to the headlight lens.

Do not use a headlight bulb of a wattage higher than specified.

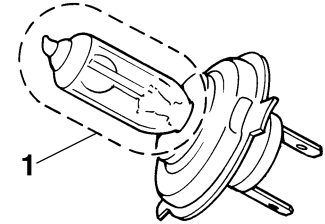

1. Do not touch the glass part of the bulb.
5. Install the headlight bulb cover, and then connect the coupler.
6. Install the panel.
7. Have a Yamaha dealer adjust the headlight beam if necessary.

To replace a low beam headlight bulb

1. Remove the headlight bulb cover by turning it counterclockwise.

PERIODIC MAINTENANCE AND MINOR REPAIR

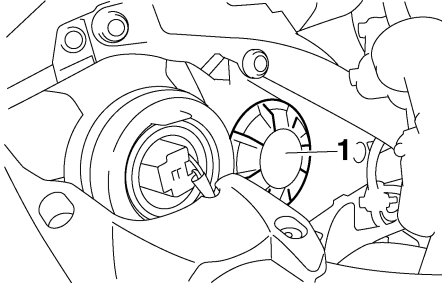

1. Headlight bulb cover

2. Disconnect the headlight coupler.

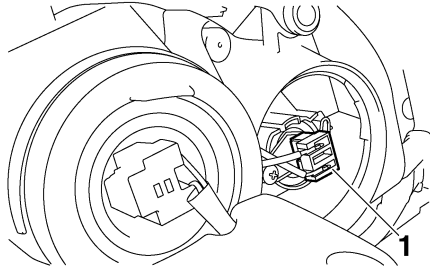

1. Headlight coupler

3. Unhook the headlight bulb holder, and then remove the defective bulb.

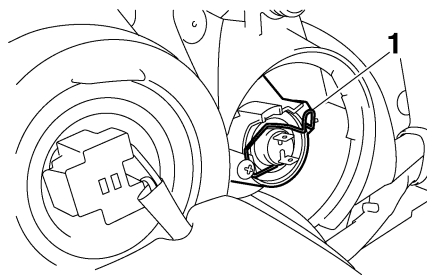

1. Headlight bulb holder

! WARNING

Headlight bulbs get very hot. Therefore, keep flammable products away from a lit headlight bulb, and do not touch the bulb until it has cooled down.

4. Place a new headlight bulb into position, and then secure it with the bulb holder.

CAUTION:

Take care not to damage the following parts:

● Headlight bulb

Do not touch the glass part of the headlight bulb to keep it free from oil, otherwise the transparency of the glass, the luminosity of the bulb, and the bulb life will be adversely affected. Thoroughly clean off any dirt and fingerprints on the headlight bulb using a cloth moistened with alcohol or thinner.

● Headlight lens

Do not affix any type of tinted film or stickers to the headlight lens.

Do not use a headlight bulb of a wattage higher than specified.

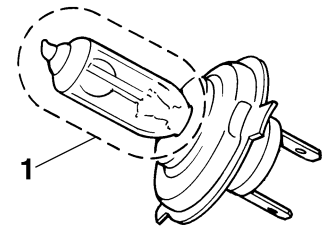

1. Do not touch the glass part of the bulb.

PERIODIC MAINTENANCE AND MINOR REPAIR

5. Connect the headlight coupler.
6. Install the headlight bulb cover by turning it clockwise.
7. Have a Yamaha dealer adjust the headlight beam if necessary.

Tail/brake light

EAU24180

This model is equipped with an LED type of tail/brake light. If the tail/brake light does not come on, have a Yamaha dealer check it.

Replacing a turn signal light bulb

EAU24202

1. Remove the turn signal light lens by removing the screw.

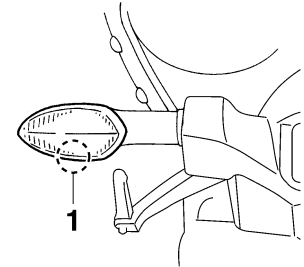

1. Screw
2. Remove the defective bulb by pushing it in and turning it counter-clockwise.
3. Insert a new bulb into the socket, push it in, and then turn it clockwise until it stops.
4. Install the lens by installing the screw.

ECA11190

CAUTION:

Do not overtighten the screw, otherwise the lens may break.

PERIODIC MAINTENANCE AND MINOR REPAIR

Replacing the license plate light bulb

EAU24310

1. Remove the license plate light unit by removing the screws.

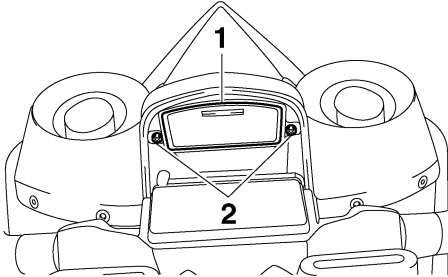

1. License plate light unit
2. Screw

2. Remove the socket (together with the bulb) by pulling it out.

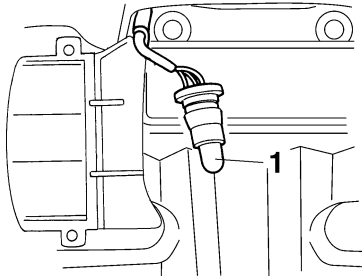

1. License plate light bulb

3. Remove the defective bulb by pulling it out.
4. Insert a new bulb into the socket.
5. Install the socket (together with the bulb) by pushing it in.
6. Install the license plate light unit by installing the screws.

Replacing an auxiliary light bulb

EAU33910

This model is equipped with two auxiliary lights. If an auxiliary light bulb burns out, replace it as follows.

1. Remove panel C (if replacing the left auxiliary light bulb) or panel D (if replacing the right auxiliary light bulb). (See page 6-9.)
2. Remove the auxiliary light bulb cover by removing the quick fastener.

NOTE:

Remove the quick fastener by pushing the center pin in with a screwdriver, then pulling the fastener out.

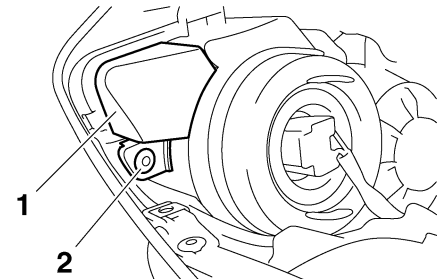

1. Auxiliary light bulb cover
2. Quick fastener

PERIODIC MAINTENANCE AND MINOR REPAIR

3. Remove the socket (together with the bulb) by pulling it out.

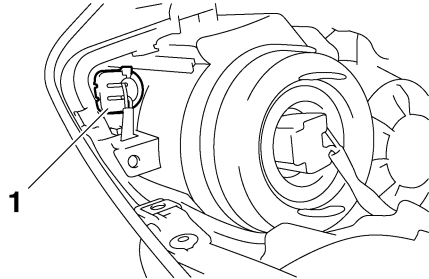

1. Auxiliary light bulb socket

4. Remove the defective bulb by pulling it out.

6

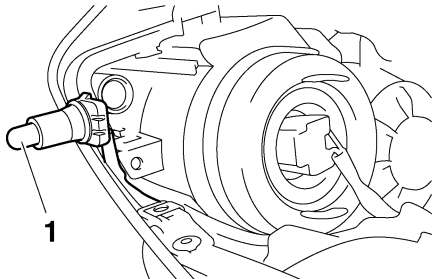

1. Auxiliary light bulb

5. Insert a new bulb into the socket.
6. Install the socket (together with the bulb) by pushing it in.

7. Install the auxiliary light bulb cover by installing the quick fastener.

NOTE: _____
To install the quick fastener, push the center pin out so that it will protrude from the fastener head, insert the fastener into the auxiliary light bulb cover, and then push the protruding pin in until it is flush with the fastener head.

8. Install the panel.

EAU24350

Supporting the motorcycle

Since this model is not equipped with a centerstand, follow these precautions when removing the front and rear wheel or performing other maintenance requiring the motorcycle to stand upright. Check that the motorcycle is in a stable and level position before starting any maintenance. A strong wooden box can be placed under the engine for added stability.

To service the front wheel

1. Stabilize the rear of the motorcycle by using a motorcycle stand or, if an additional motorcycle stand is not available, by placing a jack under the frame in front of the rear wheel.
2. Raise the front wheel off the ground by using a motorcycle stand.

To service the rear wheel

Raise the rear wheel off the ground by using a motorcycle stand or, if a motorcycle stand is not available, by placing

PERIODIC MAINTENANCE AND MINOR REPAIR

a jack either under each side of the frame in front of the rear wheel or under each side of the swingarm.

Front wheel

EAU24360

To remove the front wheel

EAU34591

EWA10820

⚠ WARNING

- It is advisable to have a Yamaha dealer service the wheel.
- Securely support the motorcycle so that there is no danger of it falling over.

1. Loosen the wheel axle pinch bolts, the axle bolt, and then the brake caliper bolts.

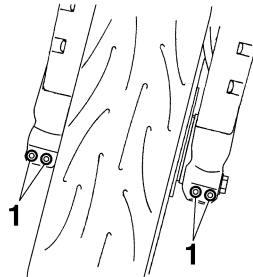

1. Front wheel axle pinch bolt

2. Lift the front wheel off the ground according to the procedure on page 6-42.

3. Remove the brake hose holder and reflector on each side by removing the bolt and nut.
4. Remove the brake caliper on each side by removing the bolts.

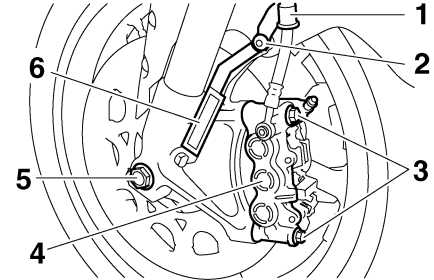

1. Brake hose holder
2. Bolt and nut
3. Brake caliper bolt
4. Brake caliper
5. Axle bolt
6. Reflector

5. Remove the axle bolt, push the wheel axle out from the left side, and then remove the wheel.

PERIODIC MAINTENANCE AND MINOR REPAIR

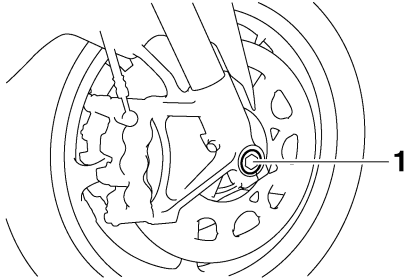

1. Wheel axle

ECA11050

CAUTION:

Do not apply the brake after the brake calipers have been removed, otherwise the brake pads will be forced shut.

6

EAU34531

To install the front wheel

1. Lift the wheel up between the fork legs.
2. Insert the wheel axle.
3. Lower the front wheel so that it is on the ground.
4. Install the brake calipers by installing the bolts, and then tightening them to the specified torque.

NOTE: _____
Make sure that there is enough space between the brake pads before installing the brake calipers onto the brake discs.

Tightening torque:
Brake caliper bolt:
35 Nm (3.5 m·kgf, 25 ft·lbf)

5. Install the brake hose holders and reflectors by installing the bolts and nuts.
6. Secure the wheel axle by installing the axle bolt, and then tightening the axle bolt to the specified torque.

NOTE: _____
While tightening the axle bolt, hold the wheel axle with a 19-mm hexagon wrench to keep it from turning.

Tightening torque:
Axle bolt:
91 Nm (9.1 m·kgf, 66 ft·lbf)

7. Tighten wheel axle pinch bolt B, and then tighten pinch bolt A to the specified torque.

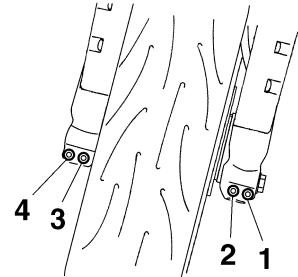

1. Front wheel axle pinch bolt A
2. Front wheel axle pinch bolt B
3. Front wheel axle pinch bolt C
4. Front wheel axle pinch bolt D

8. Retighten pinch bolt B to the specified torque.

Tightening torque:
Wheel axle pinch bolt:
21 Nm (2.1 m·kgf, 15 ft·lbf)

9. Tap the outer side of the right fork leg with a rubber mallet to align it with the end of the wheel axle.
10. Tighten wheel axle pinch bolt D, and then tighten pinch bolt C to the specified torque.

PERIODIC MAINTENANCE AND MINOR REPAIR

11. Retighten pinch bolt D to the specified torque.

Tightening torque:

Wheel axle pinch bolt:
21 Nm (2.1 m·kgf, 15 ft·lbf)

12. While applying the front brake, push down hard on the handlebar several times to check for proper fork operation.

Rear wheel

EAU25080

To remove the rear wheel

EAU25311

EWA10820

WARNING

- It is advisable to have a Yamaha dealer service the wheel.
- Securely support the motorcycle so that there is no danger of it falling over.

1. Loosen the axle nut.

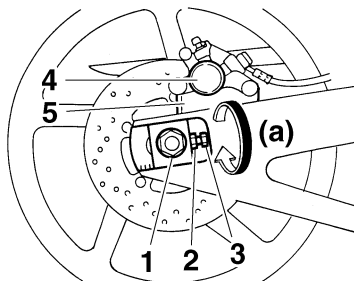

1. Axle nut
2. Drive chain slack adjusting bolt
3. Locknut
4. Brake caliper
5. Brake caliper bracket

2. Lift the rear wheel off the ground according to the procedure on page 6-42.
3. Remove the axle nut.
4. Loosen the locknut on each side of the swingarm.
5. Turn the drive chain slack adjusting bolts fully in direction (a) and push the wheel forward.
6. Remove the drive chain from the rear sprocket.

NOTE:

- If the drive chain is difficult to remove, remove the wheel axle first, and then lift the wheel upward enough to remove the drive chain from the rear sprocket.
- The drive chain cannot be disassembled.

7. While supporting the brake caliper bracket, pull the wheel axle out, and then remove the wheel.

PERIODIC MAINTENANCE AND MINOR REPAIR

EAU25870

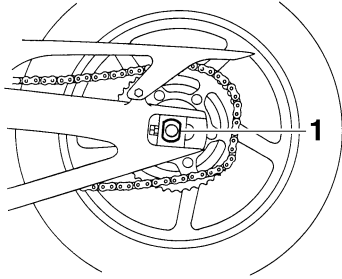

1. Wheel axle

ECA11070

CAUTION:

Do not apply the brake after the wheel has been removed together with the brake disc, otherwise the brake pads will be forced shut.

6

To install the rear wheel

EAU25661

1. Install the wheel and the brake caliper bracket by inserting the wheel axle from the left-hand side.

NOTE:

- Be sure to insert the retainer on the brake caliper bracket into the slot in the swingarm.

- Make sure that there is enough space between the brake pads before installing the wheel.

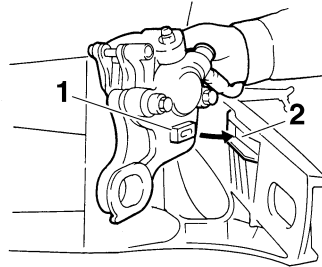

1. Retainer
2. Slot

2. Install the drive chain onto the rear sprocket.
3. Install the axle nut, and then lower the rear wheel so that it is on the ground.
4. Adjust the drive chain slack. (See page 6-28.)
5. Tighten the axle nut to the specified torque.

Tightening torque:

Axle nut:

150 Nm (15.0 m·kgf, 110 ft·lbf)

Troubleshooting

Although Yamaha motorcycles receive a thorough inspection before shipment from the factory, trouble may occur during operation. Any problem in the fuel, compression, or ignition systems, for example, can cause poor starting and loss of power.

The following troubleshooting charts represent quick and easy procedures for checking these vital systems yourself. However, should your motorcycle require any repair, take it to a Yamaha dealer, whose skilled technicians have the necessary tools, experience, and know-how to service the motorcycle properly.

Use only genuine Yamaha replacement parts. Imitation parts may look like Yamaha parts, but they are often inferior, have a shorter service life and can lead to expensive repair bills.

PERIODIC MAINTENANCE AND MINOR REPAIR

EAU42500

Troubleshooting charts

Starting problems or poor engine performance

EWA10840



WARNING

Keep away open flames and do not smoke while checking or working on the fuel system.

1. Fuel

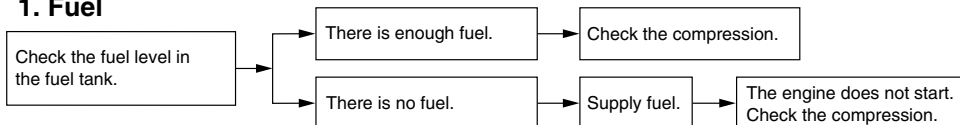

2. Compression

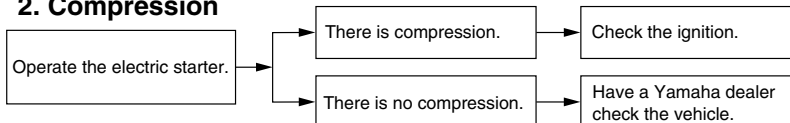

3. Ignition

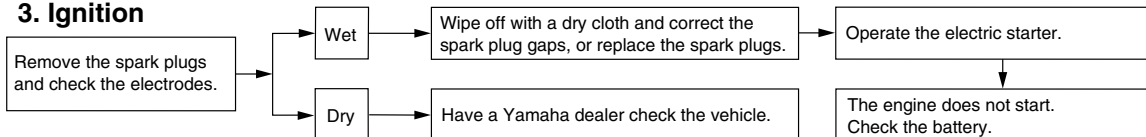

4. Battery

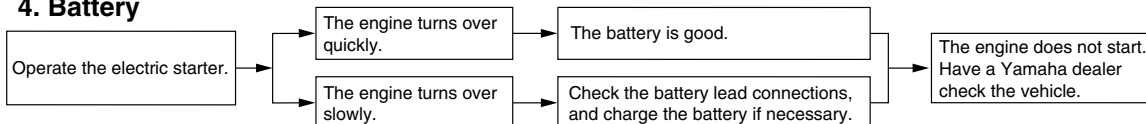

PERIODIC MAINTENANCE AND MINOR REPAIR

Engine overheating

EWAT1040

WARNING

- Do not remove the radiator cap when the engine and radiator are hot. Scalding hot fluid and steam may be blown out under pressure, which could cause serious injury. Be sure to wait until the engine has cooled.
- Place a thick rag, like a towel, over the radiator cap, and then slowly rotate the cap counterclockwise to the detent to allow any residual pressure to escape. When the hissing sound has stopped, press down on the cap while turning it counterclockwise, and then remove the cap.

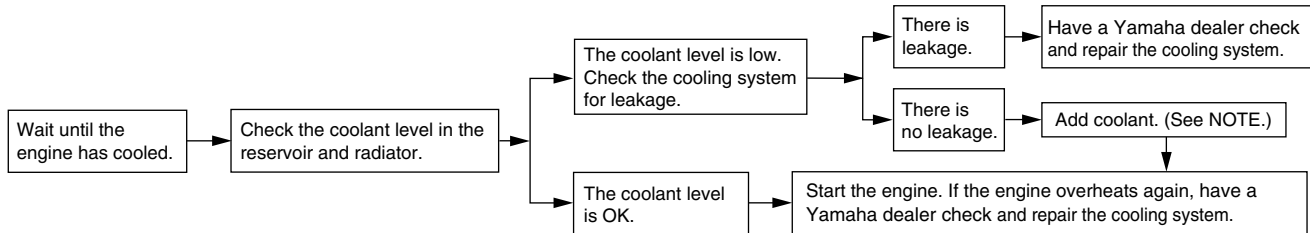

NOTE:

If coolant is not available, tap water can be temporarily used instead, provided that it is changed to the recommended coolant as soon as possible.

Matte color caution

EAU37833

CAUTION:

Some models are equipped with matte colored finished parts. Be sure to consult a Yamaha dealer for advice on what products to use before cleaning the vehicle. Using a brush, harsh chemical products or cleaning compounds when cleaning these parts will scratch or damage their surface. Wax also should not be applied to any matte colored finished parts.

ECA15192

Care

While the open design of a motorcycle reveals the attractiveness of the technology, it also makes it more vulnerable. Rust and corrosion can develop even if high-quality components are used. A rusty exhaust pipe may go unnoticed on a car, however, it detracts from the overall appearance of a motorcycle. Frequent and proper care does not only comply with the terms of the warranty, but it will also keep your motorcycle looking good, extend its life and optimize its performance.

Before cleaning

1. Cover the muffler outlets with a plastic bag after the engine has cooled down.
2. Make sure that all caps and covers as well as all electrical couplers and connectors, including the spark plug caps, are tightly installed.
3. Remove extremely stubborn dirt, like oil burnt onto the crankcase, with a degreasing agent and a brush, but never apply such prod-

EAU36901

ucts onto seals, gaskets, sprockets, the drive chain and wheel axles. Always rinse the dirt and degreaser off with water.

Cleaning

CAUTION:

ECA15090

- Avoid using strong acidic wheel cleaners, especially on spoked wheels. If such products are used on hard-to-remove dirt, do not leave the cleaner on the affected area any longer than instructed. Also, thoroughly rinse the area off with water, immediately dry it, and then apply a corrosion protection spray.
- Improper cleaning can damage windshields, cowlings, panels, other plastic parts, and the mufflers. Use only a soft, clean cloth or sponge with mild detergent and water to clean plastic. However, if the mufflers cannot be thoroughly cleaned with mild detergent, alkaline products and a soft brush may be used.

MOTORCYCLE CARE AND STORAGE

- Do not use any harsh chemical products on plastic parts or the mufflers. Be sure to avoid using cloths or sponges which have been in contact with strong or abrasive cleaning products, solvent or thinner, fuel (gasoline), rust removers or inhibitors, brake fluid, antifreeze or electrolyte.
- Do not use high-pressure washers or steam-jet cleaners since they cause water seepage and deterioration in the following areas: seals (of wheel and swing-arm bearings, fork and brakes), storage compartments, electric components (couplers, connectors, instruments, switches and lights), breather hoses and vents.
- For motorcycles equipped with a windshield: Do not use strong cleaners or hard sponges as they will cause dulling or scratching. Some cleaning compounds for plastic may leave scratches on the windshield. Test the product on a small hid-

den part of the windshield to make sure that it does not leave any marks. If the windshield is scratched, use a quality plastic polishing compound after washing.

After normal use

Remove dirt with warm water, a mild detergent, and a soft, clean sponge, and then rinse thoroughly with clean water. Use a toothbrush or bottlebrush for hard-to-reach areas. Stubborn dirt and insects will come off more easily if the area is covered with a wet cloth for a few minutes before cleaning.

After riding in the rain, near the sea or on salt-sprayed roads

Since sea salt or salt sprayed on roads during winter are extremely corrosive in combination with water, carry out the following steps after each ride in the rain, near the sea or on salt-sprayed roads.

NOTE: _____

Salt sprayed on roads in the winter may remain well into spring.

1. Clean the motorcycle with cold water and a mild detergent, after the engine has cooled down.

ECA10790

CAUTION: _____

Do not use warm water since it increases the corrosive action of the salt.

2. After drying the motorcycle, apply a corrosion protection spray on all metal, including chrome- and nickel-plated, surfaces (except the titanium mufflers) to prevent corrosion.

Cleaning the titanium mufflers

This model is equipped with titanium mufflers, which require the following special care.

- Use only a soft, clean cloth or sponge with mild detergent and water to clean the titanium mufflers. However, if the mufflers can-

MOTORCYCLE CARE AND STORAGE

ECA10800

not be thoroughly cleaned with mild detergent, alkaline products and a soft brush may be used.

- Never use compounds or other special treatments to clean the titanium mufflers, as they will remove the finish on the outer surface of the mufflers.
- Even the smallest amounts of oil, such as from oily towels or fingerprints, will leave stains on the titanium mufflers, which can be removed with a mild detergent.
- Note that the thermally induced discoloring of the portion of the exhaust pipe leading into the titanium mufflers is normal and cannot be removed.

After cleaning

1. Dry the motorcycle with a chamois or an absorbing cloth.
2. Immediately dry the drive chain and lubricate it to prevent it from rusting.
3. Use a chrome polish to shine chrome, aluminum and stainless-steel parts.

4. To prevent corrosion, it is recommended to apply a corrosion protection spray on all metal, including chrome- and nickel-plated, surfaces.
5. Use spray oil as a universal cleaner to remove any remaining dirt.
6. Touch up minor paint damage caused by stones, etc.
7. Wax all painted surfaces.
8. Let the motorcycle dry completely before storing or covering it.

EWA11130

WARNING

- **Make sure that there is no oil or wax on the brakes or tires.**
- **If necessary, clean the brake discs and brake linings with a regular brake disc cleaner or acetone, and wash the tires with warm water and a mild detergent. Before riding at higher speeds, test the motorcycle's braking performance and cornering behavior.**

CAUTION:

- **Apply spray oil and wax sparingly and make sure to wipe off any excess.**
- **Never apply oil or wax to any rubber and plastic parts, but treat them with a suitable care product.**
- **Avoid using abrasive polishing compounds as they will wear away the paint.**

NOTE:

Consult a Yamaha dealer for advice on what products to use.

MOTORCYCLE CARE AND STORAGE

Storage

EAU26201

Short-term

Always store your motorcycle in a cool, dry place and, if necessary, protect it against dust with a porous cover.

ECA10810

CAUTION:

- **Storing the motorcycle in a poorly ventilated room or covering it with a tarp, while it is still wet, will allow water and humidity to seep in and cause rust.**
- **To prevent corrosion, avoid damp cellars, stables (because of the presence of ammonia) and areas where strong chemicals are stored.**

Long-term

Before storing your motorcycle for several months:

1. Follow all the instructions in the “Care” section of this chapter.
2. Fill up the fuel tank and add fuel stabilizer (if available) to prevent the fuel tank from rusting and the fuel from deteriorating.

3. Perform the following steps to protect the cylinders, piston rings, etc. from corrosion.
 - a. Remove the spark plug caps and spark plugs.
 - b. Pour a teaspoonful of engine oil into each spark plug bore.
 - c. Install the spark plug caps onto the spark plugs, and then place the spark plugs on the cylinder head so that the electrodes are grounded. (This will limit sparking during the next step.)
 - d. Turn the engine over several times with the starter. (This will coat the cylinder walls with oil.)
 - e. Remove the spark plug caps from the spark plugs, and then install the spark plugs and the spark plug caps.

EWA10950



To prevent damage or injury from sparking, make sure to ground the spark plug electrodes while turning the engine over.

4. Lubricate all control cables and the pivoting points of all levers and pedals as well as of the side-stand/centerstand.
5. Check and, if necessary, correct the tire air pressure, and then lift the motorcycle so that both of its wheels are off the ground. Alternatively, turn the wheels a little every month in order to prevent the tires from becoming degraded in one spot.
6. Cover the muffler outlets with plastic bags to prevent moisture from entering them.
7. Remove the battery and fully charge it. Store it in a cool, dry place and charge it once a month. Do not store the battery in an excessively cold or warm place [less than 0 °C (30 °F) or more than 30 °C (90 °F)]. For more information on storing the battery, see page 6-34.

NOTE:

Make any necessary repairs before storing the motorcycle.

Dimensions:

- Overall length:
2060 mm (81.1 in)
- Overall width:
720 mm (28.3 in)
- Overall height:
1110 mm (43.7 in)
- Seat height:
835 mm (32.9 in)
- Wheelbase:
1415 mm (55.7 in)
- Ground clearance:
135 mm (5.31 in)
- Minimum turning radius:
3400 mm (133.9 in)

Weight:

- With oil and fuel:
200.0 kg (441 lb)

Engine:

- Engine type:
Liquid cooled 4-stroke, DOHC
- Cylinder arrangement:
Forward-inclined parallel 4-cylinder
- Displacement:
998.0 cm³
- Bore × stroke:
77.0 × 53.6 mm (3.03 × 2.11 in)
- Compression ratio:
12.70 :1
- Starting system:
Electric starter
- Lubrication system:
Wet sump

Engine oil:

- Type:
YAMALUBE 4, SAE10W30 or SAE20W40

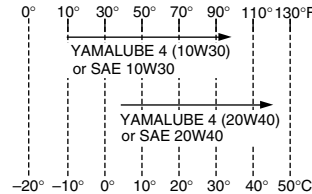

- Recommended engine oil grade:
API service SG type or higher, JASO standard MA
- Engine oil quantity:
Without oil filter cartridge replacement:
2.90 L (3.07 US qt) (2.55 Imp.qt)
With oil filter cartridge replacement:
3.10 L (3.28 US qt) (2.73 Imp.qt)

Cooling system:

- Coolant reservoir capacity (up to the maximum level mark):
0.25 L (0.26 US qt) (0.22 Imp.qt)
- Radiator capacity (including all routes):
2.76 L (2.92 US qt) (2.43 Imp.qt)

Air filter:

- Air filter element:
Oil-coated paper element

Fuel:

- Recommended fuel:
Premium unleaded gasoline only
- Fuel tank capacity:
18.0 L (4.76 US gal) (3.96 Imp.gal)
- Fuel reserve amount:
3.2 L (0.85 US gal) (0.70 Imp.gal)

Fuel injector:

- Manufacturer:
DENSO
- Model/quantity:
297500-1110/4

Spark plug (s):

- Manufacturer/model:
NGK/CR9EK
- Spark plug gap:
0.6–0.7 mm (0.024–0.028 in)

Clutch:

- Clutch type:
Wet, multiple-disc

Transmission:

- Primary reduction system:
Spur gear
- Primary reduction ratio:
65/43 (1.512)
- Secondary reduction system:
Chain drive
- Secondary reduction ratio:
45/17 (2.647)
- Transmission type:
Constant mesh 6-speed
- Operation:
Left foot operation

SPECIFICATIONS

Gear ratio:

- 1st:
38/15 (2.533)
- 2nd:
33/16 (2.063)
- 3rd:
37/21 (1.762)
- 4th:
35/23 (1.522)
- 5th:
30/22 (1.364)
- 6th:
33/26 (1.269)

Chassis:

- Frame type:
Diamond
- Caster angle:
24.00 °
- Trail:
102.0 mm (4.02 in)

Front tire:

- Type:
Tubeless
- Size:
120/70 ZR17M/C (58W)
- Manufacturer/model:
PIRELLI/DIABLO CORSA E
- Manufacturer/model:
MICHELIN/Pilot POWER P

Rear tire:

- Type:
Tubeless
- Size:
190/50 ZR17M/C (73W)

- Manufacturer/model:
PIRELLI/DIABLO CORSA L

- Manufacturer/model:
MICHELIN/Pilot POWER

Loading:

- Maximum load:
195 kg (430 lb)
(Total weight of rider, passenger, cargo and accessories)

Tire air pressure (measured on cold tires):

- Loading condition:
0–90 kg (0–198 lb)
- Front:
250 kPa (36 psi) (2.50 kgf/cm²)

- Rear:
290 kPa (42 psi) (2.90 kgf/cm²)

- Loading condition:
90–195 kg (198–430 lb)
- Front:
250 kPa (36 psi) (2.50 kgf/cm²)

- Rear:
290 kPa (42 psi) (2.90 kgf/cm²)

- High-speed riding:
Front:
250 kPa (36 psi) (2.50 kgf/cm²)
- Rear:
290 kPa (42 psi) (2.90 kgf/cm²)

Front wheel:

- Wheel type:
Cast wheel
- Rim size:
17M/C x MT3.50

Rear wheel:

- Wheel type:
Cast wheel
- Rim size:
17M/C x MT6.00

Front brake:

- Type:
Dual disc brake
- Operation:
Right hand operation
- Recommended fluid:
DOT 4

Rear brake:

- Type:
Single disc brake
- Operation:
Right foot operation
- Recommended fluid:
DOT 4

Front suspension:

- Type:
Telescopic fork
- Spring/shock absorber type:
Coil spring/oil damper
- Wheel travel:
120.0 mm (4.72 in)

Rear suspension:

- Type:
Swingarm (link suspension)
- Spring/shock absorber type:
Coil spring/gas-oil damper
- Wheel travel:
130.0 mm (5.12 in)

Electrical system:

- Ignition system:
 - Transistorized coil ignition (digital)
- Charging system:
 - AC magneto

Battery:

- Model:
 - YTZ10S
- Voltage, capacity:
 - 12 V, 8.6 Ah

Headlight:

- Bulb type:
 - Halogen bulb

Bulb voltage, wattage × quantity:

- Headlight:
 - 12 V, 55.0 W × 4
- Tail/brake light:
 - LED
- Front turn signal/position light:
 - 12 V, 21 W/5.0 W × 2
- Rear turn signal light:
 - 12 V, 21.0 W × 2
- Auxiliary light:
 - 12 V, 5.0 W × 2
- License plate light:
 - 12 V, 5.0 W × 1
- Meter lighting:
 - LED
- Neutral indicator light:
 - LED
- High beam indicator light:
 - LED
- Oil level warning light:
 - LED

- Turn signal indicator light:
 - LED
- Fuel level warning light:
 - LED
- Coolant temperature warning light:
 - LED
- Engine trouble warning light:
 - LED
- Shift timing indicator light:
 - LED

Fuses:

- Main fuse:
 - 50.0 A
- Headlight fuse:
 - 25.0 A
- Signaling system fuse:
 - 7.5 A
- Ignition fuse:
 - 15.0 A
- Radiator fan fuse:
 - 15.0 A × 2
- Fuel injection system fuse:
 - 15.0 A
- Backup fuse:
 - 7.5 A
- Electric throttle valve fuse:
 - 7.5 A

CONSUMER INFORMATION

EAU26351

Identification numbers

Record the key identification number, vehicle identification number and model label information in the spaces provided below for assistance when ordering spare parts from a Yamaha dealer or for reference in case the vehicle is stolen.

KEY IDENTIFICATION NUMBER:

VEHICLE IDENTIFICATION NUMBER:

MODEL LABEL INFORMATION:

Key identification number

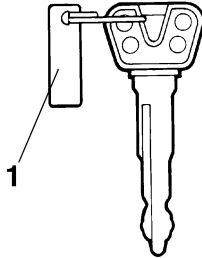

1. Key identification number

The key identification number is stamped into the key tag. Record this number in the space provided and use it for reference when ordering a new key.

EAU26381

Vehicle identification number

EAU26400

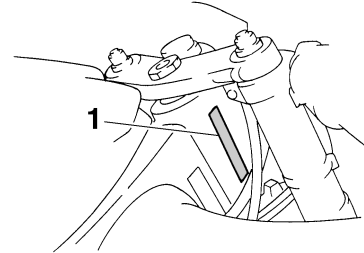

1. Vehicle identification number

The vehicle identification number is stamped into the steering head pipe. Record this number in the space provided.

NOTE: _____

The vehicle identification number is used to identify your motorcycle and may be used to register your motorcycle with the licensing authority in your area.

Model label

EAU33941

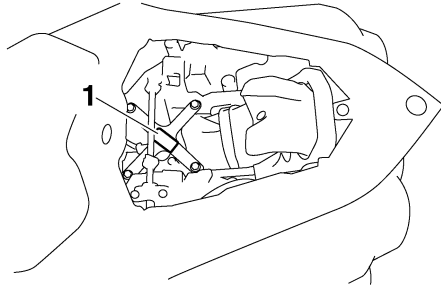

1. Model label

The model label is affixed to the frame under the passenger seat. (See page 3-15.) Record the information on this label in the space provided. This information will be needed when ordering spare parts from a Yamaha dealer.

EWA12371

WARNING

Do not touch either muffler bracket, located under the muffler bracket covers, until the exhaust system has cooled.

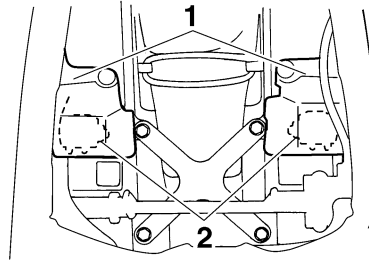

1. Muffler bracket cover
2. Muffler bracket

CONSUMER INFORMATION

EAU26551

Reporting safety defects

If you believe that your vehicle has a defect which could cause a crash or could cause injury or death, you should immediately inform the National Highway Traffic Safety Administration (NHTSA) in addition to notifying Yamaha Motor Corporation, U.S.A. If NHTSA receives similar complaints, it may open an investigation, and if it finds that a safety defect exists in a group of vehicles, it may order a recall and remedy campaign. However, NHTSA cannot become involved in individual problems between you, your dealer, or Yamaha Motor Corporation, U.S.A.

To contact NHTSA, you may call the Vehicle Safety Hotline toll-free at 1-888-327-4236 (TTY: 1-800-424-9153); go to <http://www.safercar.gov>; or write to: Administrator, NHTSA, 400 Seventh Street, SW., Washington, DC 20590. You can also obtain other information about motor vehicle safety from <http://www.safercar.gov>.

Motorcycle noise regulation

TAMPERING WITH NOISE CONTROL SYSTEM PROHIBITED:

Federal law prohibits the following acts or the causing thereof: (1) The removal or rendering inoperative by any person other than for purposes of maintenance, repair, or replacement of any device or element of design incorporated into any new vehicle for the purpose of noise control prior to its sale or delivery to the ultimate purchaser or while it is in use or (2) the use of the vehicle after such device or element of design has been removed or rendered inoperative by any person.

“AMONG THOSE ACTS PRESUMED TO CONSTITUTE TAMPERING ARE THE ACTS LISTED BELOW”.

These acts include tampering with the following systems; i.e., modification, removal, etc.

Exhaust system

- Muffler
- Exhaust pipe
- Silencer

Intake system

- Air cleaner case
- Air cleaner element
- Intake duct

CONSUMER INFORMATION

EAU26632

Maintenance record

Copies of work orders and/or receipts for parts purchased and installed on your vehicle will be required to document that maintenance has been completed in accordance with the emissions warranty. The chart below is printed only as a reminder that maintenance work is required. It is not acceptable proof of maintenance work.

Maintenance interval	Date of service	Mileage	Servicing dealer name and address	Remarks
600 mi (1000 km) or 1 month				
4000 mi (7000 km) or 6 months				
8000 mi (13000 km) or 12 months				
12000 mi (19000 km) or 18 months				
16000 mi (25000 km) or 24 months				
20000 mi (31000 km) or 30 months				
24000 mi (37000 km) or 36 months				
28000 mi (43000 km) or 42 months				
32000 mi (49000 km) or 48 months				

CONSUMER INFORMATION

Maintenance interval	Date of service	Mileage	Servicing dealer name and address	Remarks
36000 mi (55000 km) or 54 months				
40000 mi (61000 km) or 60 months				

CONSUMER INFORMATION

EAU26663

YAMAHA MOTOR CORPORATION, U.S.A. STREET AND ENDURO MOTORCYCLE LIMITED WARRANTY

Yamaha Motor Corporation, U.S.A. hereby warrants that new Yamaha motorcycles will be free from defects in material and workmanship for the period of time stated herein, subject to certain stated limitations.

THE PERIOD OF WARRANTY for Yamaha motorcycles originally equipped with headlight, stoplight, and turn signals shall be one (1) year from the date of purchase, with no mileage limitation.

MODELS EXCLUDED FROM WARRANTY include those used for non-Yamaha-authorized renting, leasing or other commercial purposes, and TZ models.

DURING THE PERIOD OF WARRANTY, any authorized Yamaha motorcycle dealer will, free of charge, repair or replace any part adjudged defective by Yamaha due to faulty workmanship or material from the factory. Parts used in warranty repairs will be warranted for the balance of the product's warranty period. All parts replaced under warranty become property of Yamaha Motor Corporation, U.S.A.

GENERAL EXCLUSIONS from this warranty shall include any failures caused by:

- Competition or racing use.
- Installation of parts or accessories that are not qualitatively equivalent to genuine Yamaha parts.
- Abnormal strain, neglect, or abuse.
- Lack of proper maintenance.
- Accident or collision damage.
- Modification to original parts.

SPECIFIC EXCLUSIONS from this warranty shall include parts replaced due to normal wear or routine maintenance.

THE CUSTOMER'S RESPONSIBILITY under this warranty shall be to:

- Operate and maintain the motorcycle as specified in the appropriate Owner's Manual, and
- Give notice to an authorized Yamaha motorcycle dealer of any and all apparent defects within ten (10) days after discovery, and make the machine available at that time for inspection and repairs at such dealer's place of business.

WARRANTY TRANSFER: To transfer the warranty from the original purchaser to any subsequent purchaser, it is imperative that the machine be inspected and registered for warranty by an authorized Yamaha motorcycle dealer. In order for this warranty to remain in effect, this inspection and registration must take place within ten (10) days after transfer. An inspection and registration fee will be charged for this service.

EMISSION CONTROL SYSTEM WARRANTY:

Yamaha Motor Corporation, U.S.A. also warrants to the ultimate purchaser and each subsequent purchaser of each Yamaha motorcycle covered by this warranty with a displacement of 50cc or greater, that the vehicle is designed, built, and equipped so as to conform at the time of sale with all U.S. emissions standards applicable at the time of manufacture and that it is free from defects in materials and workmanship which would cause it not to meet these standards within the period listed immediately below. Failures other than those resulting from defects in material or workmanship, which arise solely as a result of owner abuse and/or lack of proper maintenance, are not covered by this warranty.

Engine Displacement	Period
Under 50cc	6,000 km (3,750 miles) or five years, whichever occurs first
50cc to 169cc	12,000 km (7,465 miles) or five years whichever occurs first
170cc to 279cc	18,000 km (11,185 miles) or five years, whichever occurs first
280cc and over	30,000 km (18,641 miles) or five years, whichever occurs first

YAMAHA MOTOR CORPORATION, U.S.A. MAKES NO OTHER WARRANTY OF ANY KIND, EXPRESSED OR IMPLIED. ALL IMPLIED WARRANTIES OF MERCHANTABILITY AND FITNESS FOR A PARTICULAR PURPOSE WHICH EXCEED THE OBLIGATIONS AND TIME LIMITS STATED IN THIS WARRANTY ARE HEREBY DISCLAIMED BY YAMAHA MOTOR CORPORATION, U.S.A. AND EXCLUDED FROM THIS WARRANTY.

SOME STATES DO NOT ALLOW LIMITATIONS ON HOW LONG AN IMPLIED WARRANTY LASTS, SO THE ABOVE LIMITATION MAY NOT APPLY TO YOU. ALSO EXCLUDED FROM THIS WARRANTY ARE ANY INCIDENTAL OR CONSEQUENTIAL DAMAGES INCLUDING LOSS OF USE. SOME STATES DO NOT ALLOW THE EXCLUSION OR LIMITATION OF INCIDENTAL OR CONSEQUENTIAL DAMAGES, SO THE ABOVE EXCLUSION MAY NOT APPLY TO YOU.

THIS WARRANTY GIVES YOU SPECIFIC LEGAL RIGHTS, AND YOU MAY ALSO HAVE OTHER RIGHTS WHICH VARY FROM STATE TO STATE.

YAMAHA MOTOR CORPORATION, U.S.A.
P.O. Box 6555
Cypress, California 90630

WARRANTY QUESTIONS AND ANSWERS

- Q. What costs are my responsibility during the warranty period?
- A. The customer's responsibility includes all costs of normal maintenance services, non-warranty repairs, accident and collision damages, and oil, oil filters, air filters, spark plugs, and brake shoes.
- Q. What are some examples of "abnormal" strain, neglect, or abuse?
- A. These terms are general and overlap each other in areas. Specific examples include: Running the machine out of oil, sustained high rpm, full-throttle, operating the machine with a broken or damaged part which causes another part to fail, damage or failure due to improper or careless transportation and/or tie-down. If you have any specific questions on operation or maintenance, please contact your dealer for advice.
- Q. Does the warranty cover incidental costs such as towing or transportation due to a failure?
- A. No. The warranty is limited to repair of the machine itself.
- Q. May I perform any or all of the recommended maintenance shown in the Owner's Manual instead of having the dealer do them?
- A. Yes, if you are a qualified mechanic and follow the procedures specified in the Owner's and Service Manual. We do recommend, however, that items requiring special tools or equipment be done by a Yamaha motorcycle dealer.
- Q. Will the warranty be void or cancelled if I do not operate or maintain my new motorcycle exactly as specified in the Owner's Manual?
- A. No. The warranty on a new motorcycle cannot be "voided" or "cancelled." **However, if a particular failure is caused by operation or maintenance other than as described in the Owner's Manual, that failure may not be covered under warranty.**
- Q. What responsibility does my dealer have under this warranty?
- A. Each Yamaha motorcycle dealer is expected to:
1. Completely set up every new machine before sale.
 2. Explain the operation, maintenance, and warranty requirements to your satisfaction at the time of sale, and upon your request at any later date.
 3. Each Yamaha motorcycle dealer is held responsible for his setup, service and warranty repair work.
- Q. Is the warranty transferable to second owners?
- A. Yes. The remainder of the existing warranty can be transferred upon request. The unit has to be inspected and re-registered by an authorized Yamaha motorcycle dealer for the policy to remain effective.

CUSTOMER SERVICE

If your machine requires warranty service, you must take it to any authorized Yamaha motorcycle dealer within the continental United States. Be sure to bring your warranty registration card or other valid proof of the original date of purchase. If a question or problem arises regarding the warranty, first contact the owner of the dealership. Since all warranty matters are handled at the dealer level, this person is in the best position to help you. If you are still not satisfied and require additional assistance, please write to:

YAMAHA MOTOR CORPORATION, U.S.A.
CUSTOMER RELATIONS DEPARTMENT
P.O. Box 6555
Cypress, California 90630

When contacting Yamaha Motor Corporation, U.S.A., don't forget to include any important information such as names, addresses, model, V.I.N. (frame number), dates, and receipts.

CHANGE OF ADDRESS

The federal government requires each manufacturer of a motor vehicle to maintain a complete, up-to-date list of all first purchasers against the possibility of a safety-related defect and recall. This list is compiled from the purchase registrations sent to Yamaha Motor Corporation, U.S.A. by the selling dealer at the time of your purchase.

If you should move after you have purchased your new motorcycle, please advise us of your new address by sending a postcard listing your motorcycle model name, V.I.N. (frame number), dealer number (or dealer's name) as it is shown on your warranty card, your name and new mailing address. Mail to:

YAMAHA MOTOR CORPORATION, U.S.A.
P.O. Box 6555
Cypress, California 90630
Attention: Warranty Department

This will ensure that Yamaha Motor Corporation, U.S.A. has an up-to-date registration record in accordance with federal law.

CONSUMER INFORMATION

EAU26750

YAMAHA EXTENDED SERVICE (Y.E.S.)

Keep your Yamaha protected even after your warranty expires with genuine Yamaha Extended Service (Y.E.S.).

- Y.E.S. is designed and administered by Yamaha Motor Corporation to provide maximum owner satisfaction. You get uninterrupted factory-backed coverage for extra peace of mind.
- Y.E.S. is flexible. You choose the plan that's right for you: 12 months, 24 months, 36 months or, on certain models, even 48 months beyond your warranty period.
- Y.E.S. is designed and administered by the same Yamaha people who handle your warranty – and it shows in the comprehensive coverage benefits. There are no mileage limitations. Coverage isn't limited to “moving parts” or the “drive train” like many other plans. And Y.E.S. covers manufacturing defects just like the warranty. See the sample contract at your Yamaha dealer to see how comforting uninterrupted factory-backed protection can be.
- You don't have to pay anything for covered repairs. There's no deductible to pay, and repairs aren't “pro-rated.” You don't have any “out-of-pocket” expenses for covered repairs.
- In addition, Travel and Recreation Interruption Protection (TRIP) is included at no extra cost. TRIP gives you up to \$150 reimbursement per occurrence for any reasonable expenses you incur because your Yamaha needs covered service: replacement vehicle rental, emergency towing, phone calls, even food and lodging when you are away from home. This superb coverage goes into effect when you purchase Y.E.S., so it applies to any warranty repairs as well as covered repairs during your entire Y.E.S. plan period.
- Y.E.S. coverage is honored at any authorized Yamaha dealer nationwide.
- Y.E.S. coverage is transferable to a new owner if you sell or trade-in. That can make your Yamaha much more valuable!

This excellent Y.E.S. plan coverage is only available to Yamaha owners like you, and only while your Yamaha is still within the Yamaha Limited Warranty period. So visit your authorized Yamaha dealer to get all the facts. He can show you how easy it is to protect your investment with Yamaha Extended Service.

CONSUMER INFORMATION

We urge you to act now. You'll get the excellent benefits of TRIP coverage right away, and you'll rest easy knowing you'll have strong factory-backed protection even after your Yamaha Limited Warranty expires.

A special note:

If visiting your dealer isn't convenient, contact Yamaha with your Primary ID number (your frame number). We'll be happy to help you get the Y.E.S. coverage you need.

Yamaha Service Marketing

P.O. Box 6555

Cypress, CA 90630

1-(866)-YES-EXTD (1-866-937-3983)

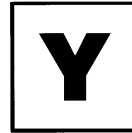

YAMAHA



EXTENDED

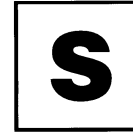

SERVICE

INDEX

A

- Accessories and replacement parts..... 6-24
- Air filter element, replacing 6-19
- Auxiliary light bulb, replacing 6-41

B

- Battery..... 6-34
- Brake and clutch levers,
checking and lubricating 6-31
- Brake fluid, changing 6-28
- Brake fluid level, checking 6-27
- Brake lever..... 3-12
- Brake pedal..... 3-13

C

- Cables, checking and lubricating 6-30
- Canister (for California only) 6-13
- Care 7-1
- Catalytic converter 3-15
- Clutch lever 3-12
- Clutch lever free play, adjusting 6-25
- Coolant..... 6-16
- Coolant temperature warning light 3-3
- Cowlings and panels,
removing and installing 6-9

D

- Dimmer switch 3-11
- Drive chain, cleaning and lubricating 6-29
- Drive chain slack..... 6-28

E

- Engine break-in..... 5-3
- Engine oil and oil filter cartridge 6-13
- Engine stop switch 3-11
- Engine trouble warning light..... 3-5
- EXUP system..... 3-21

F

- Front and rear brake pads, checking.... 6-26
- Front fork, adjusting..... 3-17
- Front fork, checking..... 6-32
- Fuel..... 3-14
- Fuel level warning light 3-3
- Fuel tank cap 3-13
- Fuses, replacing 6-35

H

- Handlebar switches 3-11
- Headlight bulb, replacing 6-37
- Helmet holders 3-16
- High beam indicator light 3-2
- Horn switch..... 3-11

I

- Identification numbers 9-1
- Ignition circuit cut-off system 3-22
- Indicator and warning lights..... 3-2

K

- Key identification number 9-1

L

- Labels, location of..... 1-5
- License plate light bulb, replacing 6-41
- Luggage strap holders..... 3-21

M

- Main switch/steering lock..... 3-1
- Maintenance and lubrication, periodic 6-4
- Maintenance, emission control system... 6-3
- Maintenance, periodic 6-1
- Maintenance record..... 9-5
- Matte color, caution 7-1
- Model label 9-2
- Multi-function meter unit 3-5

N

- Neutral indicator light 3-2
- Noise regulation 9-4

O

- Oil level warning light 3-2

P

- Parking 5-4
- Part locations 2-1
- Pre-operation check list..... 4-2

R

- Rear brake light switch, adjusting 6-26

S

- Safety defects, reporting 9-3
- Safety information 1-1
- Seats 3-15
- Shifting 5-2
- Shift pedal 3-12
- Shift pedal, checking and lubricating..... 6-31
- Shift timing indicator light 3-5
- Shock absorber assembly, adjusting 3-19
- Sidestand 3-22
- Sidestand, checking and lubricating..... 6-32
- Spark plugs, checking 6-12
- Specifications 8-1
- Starting the engine 5-1
- Start switch..... 3-11
- Steering, checking..... 6-33
- Storage..... 7-4
- Supporting the motorcycle 6-42
- Swingarm pivots, lubricating 6-32

T

- Tail/brake light..... 6-40
- Throttle cable free play, checking 6-21

Throttle grip and cable, checking and lubricating.....	6-30
Tires.....	6-22
Tool kit.....	6-1
Troubleshooting.....	6-46
Troubleshooting charts.....	6-47
Turn signal indicator lights.....	3-2
Turn signal light bulb, replacing.....	6-40
Turn signal switch.....	3-11

V

Valve clearance.....	6-21
Vehicle identification number.....	9-1

W

Warranty, extended.....	9-9
Warranty, limited.....	9-7
Wheel bearings, checking.....	6-34
Wheel (front).....	6-43
Wheel (rear).....	6-45
Wheels.....	6-24

PROTECT YOUR INVESTMENT

Use Genuine YAMAHA Parts And Accessories

See your Authorized YAMAHA Dealer for a Genuine YAMAHA Service Manual.



YAMAHA MOTOR CO., LTD.

PRINTED ON RECYCLED PAPER

PRINTED IN JAPAN
2006.10-4.2×3 CR
(E)