



**OWNER'S MANUAL**

# **FJR1300AE**

**MOTORCYCLE**

 **Read this manual carefully before operating this vehicle.**

# ***FJR13AESM***

**B96-28199-75**

 **Read this manual carefully before operating this vehicle. This manual should stay with this vehicle if it is sold.**

Congratulations on your purchase of the Yamaha FJR13AESM. This model is the result of Yamaha's vast experience in the production of fine sporting, touring, and pacesetting racing machines. It represents the high degree of craftsmanship and reliability that have made Yamaha a leader in these fields.

This manual will give you an understanding of the operation, inspection, and basic maintenance of this motorcycle. If you have any questions concerning the operation or maintenance of your motorcycle, please consult a Yamaha dealer.

The design and manufacture of this Yamaha motorcycle fully comply with the emissions standards for clean air applicable at the date of manufacture. Yamaha has met these standards without reducing the performance or economy of operation of the motorcycle. To maintain these high standards, it is important that you and your Yamaha dealer pay close attention to the recommended maintenance schedules and operating instructions contained within this manual.

Yamaha continually seeks advancements in product design and quality. Therefore, while this manual contains the most current product information available at the time of printing, there may be minor discrepancies between your motorcycle and this manual. If there is any question concerning this manual, please consult a Yamaha dealer.

---

** WARNING**

**Please read this manual carefully and completely before operating this motorcycle. Do not attempt to operate this motorcycle until you have attained adequate knowledge of its controls and operating features and until you have been trained in safe and proper riding techniques. Regular inspections and careful maintenance, along with good riding skills, will ensure that you safely enjoy the capabilities and the reliability of this motorcycle.**





---

# Important manual information

---

EAU63350

Particularly important information is distinguished in this manual by the following notations:

	<b>This is the safety alert symbol. It is used to alert you to potential personal injury hazards. Obey all safety messages that follow this symbol to avoid possible injury or death.</b>
	<b>A WARNING indicates a hazardous situation which, if not avoided, could result in death or serious injury.</b>
	<b>A NOTICE indicates special precautions that must be taken to avoid damage to the vehicle or other property.</b>
	<b>A TIP provides key information to make procedures easier or clearer.</b>

\*Product and specifications are subject to change without notice.

EAU10201

**FJR13AESM  
OWNER'S MANUAL  
©2021 by Yamaha Motor Co., Ltd.  
1st edition, July 2020  
All rights reserved.  
Any reprinting or unauthorized use  
without the written permission of  
Yamaha Motor Co., Ltd.  
is expressly prohibited.  
Printed in Japan.**

# Table of contents

Location of important labels.....1-1

Safety information .....2-1

Description .....3-1

Left view .....3-1

Right view.....3-2

Controls and instruments.....3-3

Instrument and control functions...4-1

Immobilizer system .....4-1

Main switch/steering lock .....4-2

Indicator lights and warning  
lights .....4-4

Cruise control system .....4-6

Multi-function meter unit.....4-9

D-mode (drive mode) .....4-22

Handlebar switches.....4-22

Clutch lever .....4-24

Shift pedal .....4-24

Brake lever .....4-25

Brake pedal .....4-25

ABS .....4-26

Traction control system.....4-27

Fuel tank cap.....4-28

Fuel.....4-29

Fuel tank breather/overflow  
hose .....4-30

Catalytic converters .....4-31

Seats .....4-31

Adjusting the rider seat height .....4-33

Storage compartments .....4-35

Accessory box.....4-36

Adjusting the headlight beams.....4-37

Handlebar position.....4-37

Opening and closing the cowling  
vents .....4-38

Rear view mirrors .....4-39

Adjusting the front and rear  
suspension.....4-40

Auxiliary DC jack .....4-44

Sidestand .....4-45

Ignition circuit cut-off system.....4-46

Cornering lights .....4-48

For your safety – pre-operation  
checks .....5-1

Operation and important riding  
points.....6-1

Starting the engine.....6-2

Shifting.....6-3

Engine break-in.....6-4

Parking.....6-5

Periodic maintenance and  
adjustment .....7-1

Tool kit .....7-2

Periodic maintenance chart for the  
emission control system.....7-3

General maintenance and  
lubrication chart.....7-4

Removing and installing panels .....7-7

Checking the spark plugs .....7-10

Engine oil and oil filter cartridge ...7-11

Why Yamalube.....7-14

Final gear oil.....7-14

Coolant .....7-16

Cleaning the air filter element .....7-17

Checking the engine idling  
speed.....7-19

Checking the throttle grip free  
play.....7-19

Valve clearance.....7-20

Tires .....7-20

Cast wheels .....7-23

Clutch lever .....7-23

Checking the brake lever free  
play.....7-24

Brake light switches.....7-24

Checking the front and rear  
brake pads.....7-25

Checking the brake and clutch  
fluid levels.....7-26

Changing the brake and clutch  
fluids .....7-27

Checking and lubricating the  
cables .....7-28

Checking and lubricating the  
throttle grip and cable .....7-28

# Table of contents

---

Checking and lubricating the brake and shift pedals.....	7-29
Checking and lubricating the brake and clutch levers.....	7-29
Checking and lubricating the centerstand and sidestand .....	7-30
Lubricating the rear suspension ...	7-30
Lubricating the swingarm pivots .....	7-31
Checking the front fork.....	7-31
Checking the steering.....	7-32
Checking the wheel bearings .....	7-32
Battery .....	7-33
Replacing the fuses .....	7-34
Vehicle lights .....	7-36
Troubleshooting.....	7-36
Troubleshooting charts.....	7-37
<b>Motorcycle care and storage.....</b>	<b>8-1</b>
Matte color caution .....	8-1
Care .....	8-1
Storage.....	8-4
<b>Specifications.....</b>	<b>9-1</b>
<b>Consumer information.....</b>	<b>10-1</b>
Identification numbers.....	10-1
Diagnostic connector .....	10-3
Vehicle data recording.....	10-3
Reporting safety defects .....	10-5
Maintenance record .....	10-6
YAMAHA MOTOR CANADA LTD. MOTORCYCLE WARRANTY GUIDE .....	10-7
<b>Index.....</b>	<b>11-1</b>

# Location of important labels

EAU63360

Read and understand all of the labels on your vehicle. They contain important information for safe and proper operation of your vehicle. Never remove any labels from your vehicle. If a label becomes difficult to read or comes off, a replacement label is available from your Yamaha dealer.

1

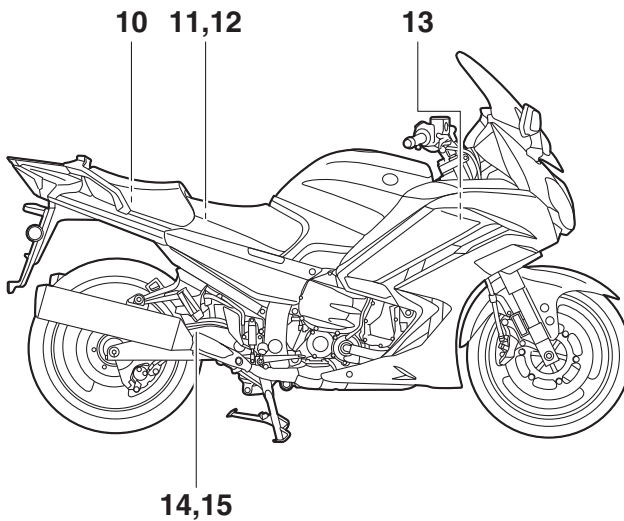
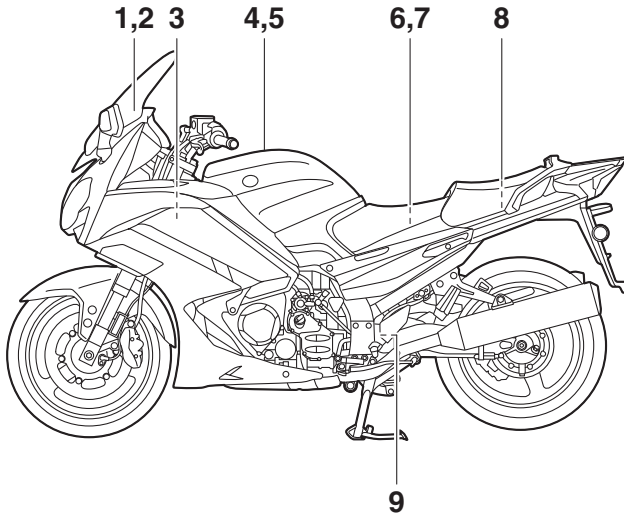

# Location of important labels

1

1

**NOTICE**

- Cleaning with alkaline or acid cleaner, gasoline or solvent will damage windshield.
- Use neutral detergent.

4BS-2815K-00

2

**ATTENTION**

- Eviter de nettoyer le pare-brise avec une solution alcaline ou acide ainsi qu'avec de l'essence ou un diluant.
- Utiliser un détergent neutre.

4BS-2815K-10

3

**CAN ICES-2 / NMB-2**

8KM-82377-30

4

**⚠ WARNING**

- **BEFORE YOU OPERATE THIS VEHICLE, READ THE OWNER'S MANUAL AND ALL LABELS.**
- **ALWAYS WEAR AN APPROVED MOTORCYCLE HELMET**, eye protection, and protective clothing.

1TP-2118K-A1

5

**⚠ AVERTISSEMENT**

- **LIRE LE MANUEL DU PROPRIETAIRE AINSI QUE TOUTES LES ETIQUETTES AVANT D'UTILISER CE VEHICULE.**
- **TOUJOURS PORTER UN CASQUE DE MOTOCYCLISTE APPROUVE**, des lunettes et des vêtements de protection.

1TP-2118K-B1

6

**⚠ AVERTISSEMENT**

Un chargement incorrect risque de causer une perte de contrôle.  
Lire le manuel du propriétaire pour le chargement convenable.

3JJ-28446-B1



# Location of important labels

7

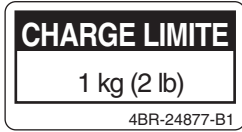

8

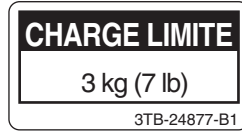

9



10

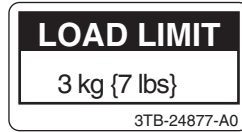

11

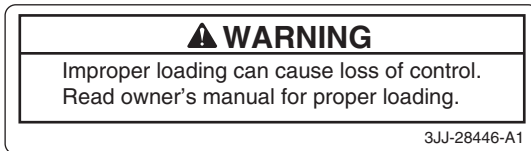

12

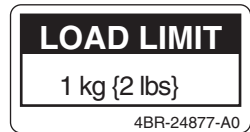

13



14

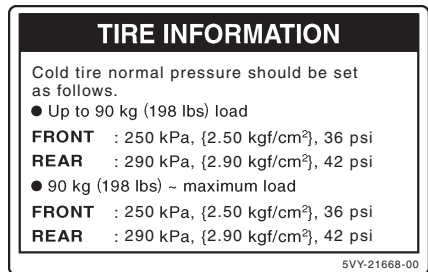

15



## Be a Responsible Owner

As the vehicle's owner, you are responsible for the safe and proper operation of your motorcycle.

Motorcycles are single-track vehicles. Their safe use and operation are dependent upon the use of proper riding techniques as well as the expertise of the operator. Every operator should know the following requirements before riding this motorcycle.

He or she should:

- Obtain thorough instructions from a competent source on all aspects of motorcycle operation.
- Observe the warnings and maintenance requirements in this Owner's Manual.
- Obtain qualified training in safe and proper riding techniques.
- Obtain professional technical service as indicated in this Owner's Manual and/or when made necessary by mechanical conditions.
- Never operate a motorcycle without proper training or instruction. Take a training course. Beginners should receive training from a certified instructor. Contact an authorized motorcycle dealer to find out about the training courses nearest you.

## Safe Riding

Perform the pre-operation checks each time you use the vehicle to make sure it is in safe operating condition. Failure to inspect or maintain the vehicle properly increases the possibility of an accident or equipment damage.

See page 5-1 for a list of pre-operation checks.

- This motorcycle is designed to carry the operator and a passenger.
- The failure of motorists to detect and recognize motorcycles in traffic is the predominating cause of automobile/motorcycle accidents. Many accidents have been caused by an automobile driver who did not see the motorcycle. Making yourself conspicuous appears to be very effective in reducing the chance of this type of accident.

### Therefore:

- Wear a brightly colored jacket.
- Use extra caution when you are approaching and passing through intersections, since intersections are the most likely places for motorcycle accidents to occur.
- Ride where other motorists can see you. Avoid riding in another motorist's blind spot.
- Never maintain a motorcycle without proper knowledge. Contact an authorized motorcycle dealer to inform you on basic motorcycle maintenance. Certain maintenance can only be carried out by certified staff.

- Many accidents involve inexperienced operators. In fact, many operators who have been involved in accidents do not even have a current motorcycle license.
  - Make sure that you are qualified and that you only lend your motorcycle to other qualified operators.
  - Know your skills and limits. Staying within your limits may help you to avoid an accident.
  - We recommend that you practice riding your motorcycle where there is no traffic until you have become thoroughly familiar with the motorcycle and all of its controls.
- Many accidents have been caused by error of the motorcycle operator. A typical error made by the operator is veering wide on a turn due to excessive speed or undercornering (insufficient lean angle for the speed).
  - Always obey the speed limit and never travel faster than warranted by road and traffic conditions.
  - Always signal before turning or changing lanes. Make sure that other motorists can see you.
- The posture of the operator and passenger is important for proper control.
  - The operator should keep both hands on the handlebar and both feet on the operator footrests during operation to maintain control of the motorcycle.
  - The passenger should always hold onto the operator, the seat strap or grab bar, if equipped, with both hands and keep both feet on the passenger footrests. Never carry a passenger unless he or she can firmly place both feet on the passenger footrests.
- Never ride under the influence of alcohol or other drugs.
- This motorcycle is designed for on-road use only. It is not suitable for off-road use.

### **Protective Apparel**

The majority of fatalities from motorcycle accidents are the result of head injuries. The use of a safety helmet is the single most critical factor in the prevention or reduction of head injuries.

- Always wear an approved helmet.
- Wear a face shield or goggles. Wind in your unprotected eyes could contribute to an impairment of vision that could delay seeing a hazard.
- The use of a jacket, heavy boots, trousers, gloves, etc., is effective in preventing or reducing abrasions or lacerations.
- Never wear loose-fitting clothes, otherwise they could catch on the control levers, footrests, or wheels and cause injury or an accident.
- Always wear protective clothing that covers your legs, ankles, and feet. The engine or exhaust system become very hot during or after operation and can cause burns.
- A passenger should also observe the above precautions.

# Safety information

2

## **Avoid Carbon Monoxide Poisoning**

All engine exhaust contains carbon monoxide, a deadly gas. Breathing carbon monoxide can cause headaches, dizziness, drowsiness, nausea, confusion, and eventually death.

Carbon Monoxide is a colorless, odorless, tasteless gas which may be present even if you do not see or smell any engine exhaust. Deadly levels of carbon monoxide can collect rapidly and you can quickly be overcome and unable to save yourself. Also, deadly levels of carbon monoxide can linger for hours or days in enclosed or poorly ventilated areas. If you experience any symptoms of carbon monoxide poisoning, leave the area immediately, get fresh air, and **SEEK MEDICAL TREATMENT**.

- Do not run engine indoors. Even if you try to ventilate engine exhaust with fans or open windows and doors, carbon monoxide can rapidly reach dangerous levels.
- Do not run engine in poorly ventilated or partially enclosed areas such as barns, garages, or carports.
- Do not run engine outdoors where engine exhaust can be drawn into a building through openings such as windows and doors.

## **Loading**

Adding accessories or cargo to your motorcycle can adversely affect stability and handling if the weight distribution of the motorcycle is changed. To avoid the possibility of an accident, use extreme caution when adding cargo or accessories to your motorcycle. Use

extra care when riding a motorcycle that has added cargo or accessories. Here, along with the information about accessories below, are some general guidelines to follow if loading cargo to your motorcycle:

The total weight of the operator, passenger, accessories and cargo must not exceed the maximum load limit.

**Operation of an overloaded vehicle could cause an accident.**

<p><b>Maximum load:</b> 213 kg (470 lb)</p>
---

When loading within this weight limit, keep the following in mind:

- Cargo and accessory weight should be kept as low and close to the motorcycle as possible. Securely pack your heaviest items as close to the center of the vehicle as possible and make sure to distribute the weight as evenly as possible on both sides of the motorcycle to minimize imbalance or instability.
- Shifting weights can create a sudden imbalance. Make sure that accessories and cargo are securely attached to the motorcycle before riding. Check accessory mounts and cargo restraints frequently.
- Properly adjust the suspension for your load (suspension-adjustable models only), and check the condition and pressure of your tires.
- Never attach any large or heavy items to the handlebar, front fork, or front fender. These items, including such cargo as

sleeping bags, duffel bags, or tents, can create unstable handling or a slow steering response.

- **This vehicle is not designed to pull a trailer or to be attached to a sidecar.**

### **Genuine Yamaha Accessories**

Choosing accessories for your vehicle is an important decision. Genuine Yamaha accessories, which are available only from a Yamaha dealer, have been designed, tested, and approved by Yamaha for use on your vehicle.

Many companies with no connection to Yamaha manufacture parts and accessories or offer other modifications for Yamaha vehicles. Yamaha is not in a position to test the products that these aftermarket companies produce. Therefore, Yamaha can neither endorse nor recommend the use of accessories not sold by Yamaha or modifications not specifically recommended by Yamaha, even if sold and installed by a Yamaha dealer.

### **Aftermarket Parts, Accessories, and Modifications**

While you may find aftermarket products similar in design and quality to genuine Yamaha accessories, recognize that some aftermarket accessories or modifications are not suitable because of potential safety hazards to you or others. Installing aftermarket products or having other modifications performed to your vehicle that change any of the vehicle's design or operation characteristics can put you and others

at greater risk of serious injury or death. You are responsible for injuries related to changes in the vehicle.

Keep the following guidelines in mind, as well as those provided under "Loading" when mounting accessories.

- Never install accessories or carry cargo that would impair the performance of your motorcycle. Carefully inspect the accessory before using it to make sure that it does not in any way reduce ground clearance or cornering clearance, limit suspension travel, steering travel or control operation, or obscure lights or reflectors.
- Accessories fitted to the handlebar or the front fork area can create instability due to improper weight distribution or aerodynamic changes. If accessories are added to the handlebar or front fork area, they must be as lightweight as possible and should be kept to a minimum.
- Bulky or large accessories may seriously affect the stability of the motorcycle due to aerodynamic effects. Wind may attempt to lift the motorcycle, or the motorcycle may become unstable in cross winds. These accessories may also cause instability when passing or being passed by large vehicles.
- Certain accessories can displace the operator from his or her normal riding position. This improper position limits the freedom of movement of the

## Safety information

---

operator and may limit control ability, therefore, such accessories are not recommended.

- Use caution when adding electrical accessories. If electrical accessories exceed the capacity of the motorcycle's electrical system, an electric failure could result, which could cause a dangerous loss of lights or engine power.

handlebars or turn signals, or parts that could break). Choose the location for the straps carefully so the straps will not rub against painted surfaces during transport.

- The suspension should be compressed somewhat by the tie-downs, if possible, so that the motorcycle will not bounce excessively during transport.

2

### **Aftermarket Tires and Rims**

The tires and rims that came with your motorcycle were designed to match the performance capabilities and to provide the best combination of handling, braking, and comfort. Other tires, rims, sizes, and combinations may not be appropriate. See page 7-20 for tire specifications and for information on servicing and replacing your tires.

### **Transporting the Motorcycle**

Be sure to observe following instructions before transporting the motorcycle in another vehicle.

- Remove all loose items from the motorcycle.
- Check that the fuel cock (if equipped) is in the off position and that there are no fuel leaks.
- Shift the transmission into gear (for models with a manual transmission).
- Secure the motorcycle with tie-downs or suitable straps that are attached to solid parts of the motorcycle, such as the frame or upper front fork triple clamp (and not, for example, to rubber-mounted

## Left view

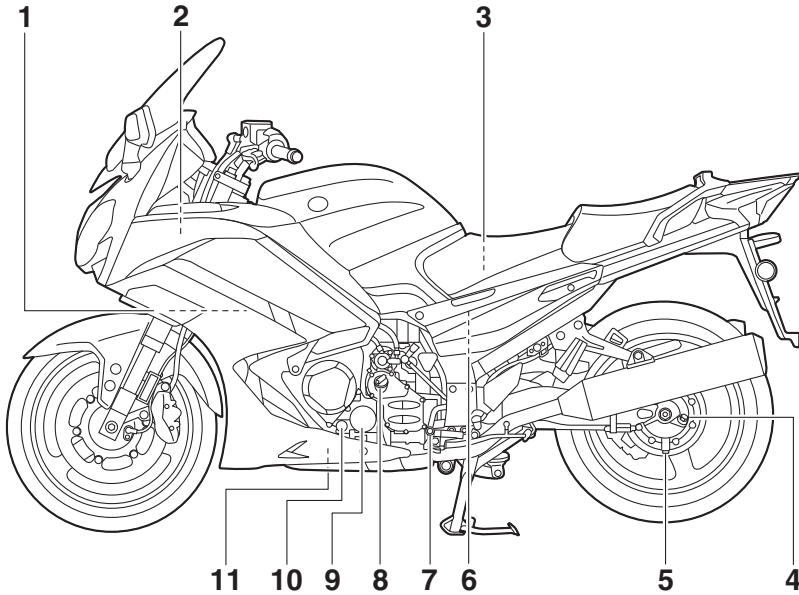

1. Coolant reservoir (page 7-16)
2. Accessory box (page 4-36)
3. Tool kit (page 7-2)
4. Final gear oil filler bolt (page 7-14)
5. Final gear oil drain bolt (page 7-14)
6. Air filter element (page 7-17)
7. Shift pedal (page 4-24)
8. Engine oil filler cap (page 7-11)
9. Engine oil filter cartridge (page 7-11)
10. Engine oil level check window (page 7-11)
11. Engine oil drain bolt (page 7-11)

# Description

EAU63391

## Right view

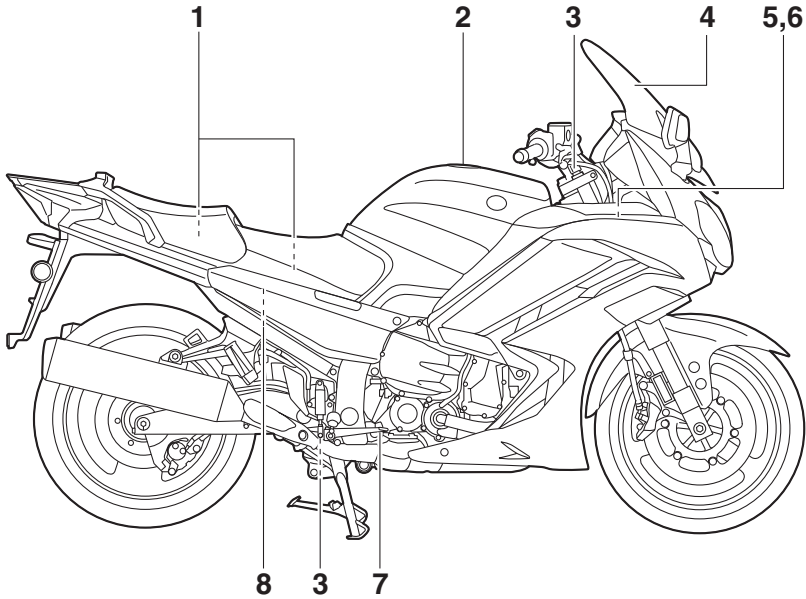

1. Storage compartment (page 4-35)
2. Fuel tank cap (page 4-28)
3. Electronically adjustable suspension system (page 4-40)
4. Windshield (page 4-12)
5. Fuses (page 7-34)
6. Battery (page 7-33)
7. Brake pedal (page 4-25)
8. Rear brake fluid reservoir (page 7-26)



## Controls and instruments

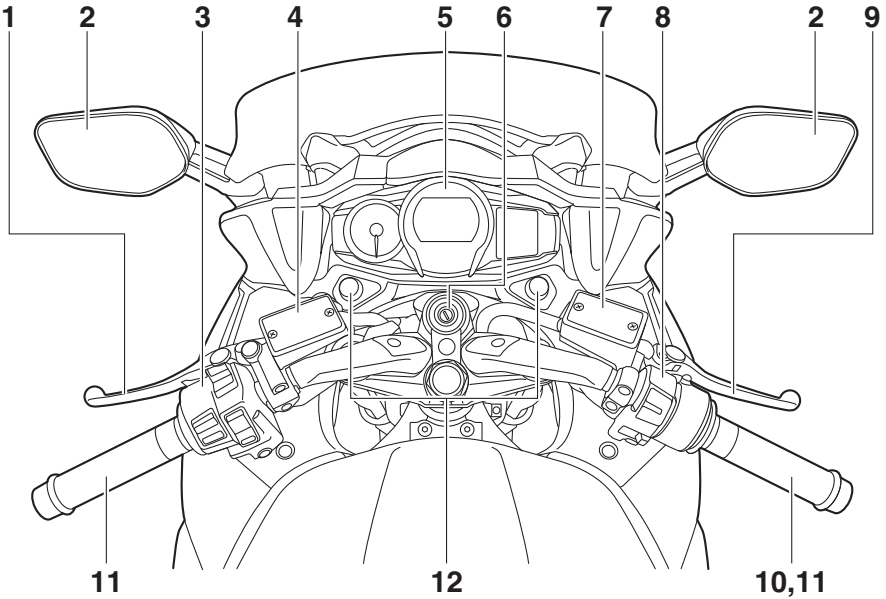

1. Clutch lever (page 4-24)
2. Rear view mirror (page 4-39)
3. Left handlebar switches (page 4-22)
4. Clutch fluid reservoir (page 7-26)
5. Multi-function meter unit (page 4-9)
6. Main switch/steering lock (page 4-2)
7. Front brake fluid reservoir (page 7-26)
8. Right handlebar switches (page 4-22)
9. Brake lever (page 4-25)
10. Throttle grip (page 7-19)
11. Grip warmer (page 4-12)
12. Headlight beam adjusting knob (page 4-37)

# Instrument and control functions

## Immobilizer system

EAU36587

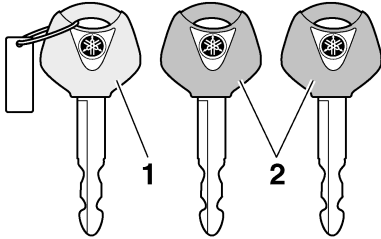

1. Code re-registering key (red bow)
2. Standard keys (black bow)

This vehicle is equipped with an immobilizer system to help prevent theft by re-registering codes in the standard keys. This system consists of the following:

- a code re-registering key
- two standard keys
- a transponder (in each key)
- an immobilizer unit (on the vehicle)
- the ECU (on the vehicle)
- a system indicator light (page 4-5)

### Industry Canada standards

This device complies with Industry Canada license-exempt RSS standards. Operation is subject to the following two conditions:

- (1) this device may not cause interference, and
- (2) this device must accept any interference, including interference that may cause undesired operation of this device.

### About the keys

The key with the red bow is used to register codes in each standard key. Store the code re-registering key in a safe place. When necessary, take the

vehicle along with all three keys to a Yamaha dealer to have them re-registered.

Do not use the key with the red bow for driving. It should only be used for re-registering the standard keys. Always use a standard key for driving.

### TIP

- Keep the standard keys as well as keys of other immobilizer systems away from the code re-registering key.
- Keep other immobilizer system keys away from the main switch as they may cause signal interference.

ECA11823

### NOTICE

**DO NOT LOSE THE CODE RE-REGISTERING KEY! CONTACT YOUR DEALER IMMEDIATELY IF IT IS LOST! If the code re-registering key is lost, the existing standard keys can still be used to start the vehicle. However, registering a new standard key is impossible. If all keys have been lost or damaged, the entire immobilizer system must be replaced. Therefore, handle the keys carefully.**

- Do not submerge in water.
- Do not expose to high temperatures.
- Do not place near magnets.
- Do not place near items that transmit electrical signals.
- Do not handle roughly.
- Do not grind or alter.
- Do not disassemble.

# Instrument and control functions

- Do not put two keys of any immobilizer system on the same key ring.

## Main switch/steering lock

EAU10474

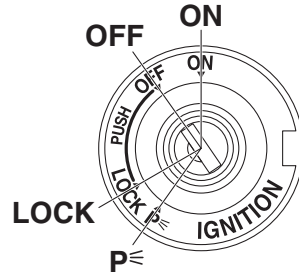

The main switch/steering lock controls the ignition and lighting systems, and is used to lock the steering. The various positions are described below.

### TIP

Be sure to use the standard key (black bow) for regular use of the vehicle. To minimize the risk of losing the code re-registering key (red bow), keep it in a safe place and only use it for code re-registering.

### ON

EAU85040

All electrical circuits are supplied with power and the vehicle lights are turned on. The engine can be started. The key cannot be removed.

### TIP

- To prevent battery discharge, do not leave the key in the on position without the engine running.
- The headlight comes on automatically when the engine is started.

### OFF

EAU10662

All electrical systems are off. The key can be removed.

# Instrument and control functions

## **! WARNING**

EWA10062

Never turn the key to “OFF” or “LOCK” while the vehicle is moving. Otherwise the electrical systems will be switched off, which may result in loss of control or an accident.

## **LOCK**

EAU10696

The steering is locked and all electrical systems are off. The key can be removed.

### To lock the steering

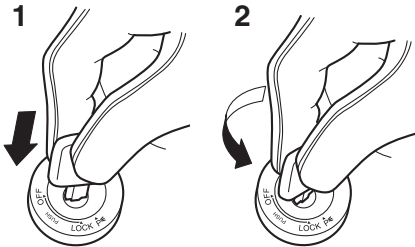

1. Push.
2. Turn.
  1. Turn the handlebars all the way to the left or right.
  2. With the key in the “OFF” position, push the key in and turn it to “LOCK”.
  3. Remove the key.

## **TIP**

If the steering will not lock, try turning the handlebars back to the right or left slightly.

### To unlock the steering

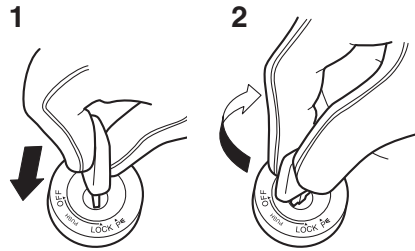

1. Push.
2. Turn.

From the “LOCK” position, push the key and turn it to “OFF”.

## **p (Parking)**

EAU65680

The hazard lights can be turned on, but all other electrical systems are off. The key can be removed.

The steering must be locked before the key can be turned to “p”.







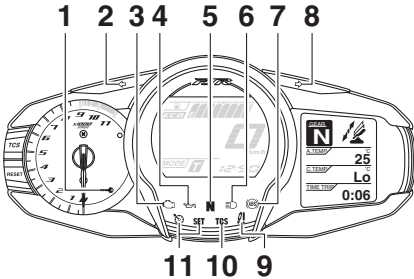

ECA22330

## **NOTICE**

**Using the hazard lights for an extended length of time may cause the battery to discharge.**

## Indicator lights and warning lights



1. Immobilizer system indicator light “”
2. Left turn signal indicator light “”
3. Engine trouble warning light “”
4. Oil level warning light “”
5. Neutral indicator light “**N**”
6. High beam indicator light “”
7. ABS warning light “”
8. Right turn signal indicator light “”
9. Suspension system warning light “”
10. Traction control system indicator light “**TCS**”
11. Cruise control indicator lights “” “**SET**”

### Turn signal indicator lights “” and “”

EAU11032

Each indicator light will flash when its corresponding turn signal lights are flashing.

### Neutral indicator light “**N**”

EAU11061

This indicator light comes on when the transmission is in the neutral position.

### High beam indicator light “”

EAU11081

This indicator light comes on when the high beam of the headlight is switched on.

### Oil level warning light “”

This warning light comes on when the engine oil level is low. To prevent engine damage, replenish the engine oil as soon as possible.

Even if the oil level is sufficient, the warning light may flicker when riding on a slope or during sudden acceleration or deceleration, but this is not a malfunction.

#### TIP

When the vehicle is turned on, this light will come on for a few seconds and then go off. If the light does not come on, or if the light remains on after confirming that the oil level is correct (see page 7-11), have a Yamaha dealer check the vehicle.

### Cruise control indicator lights “” and “**SET**”

EAU58402

These indicator lights come on when the cruise control system is activated. (See page 4-6.)

#### TIP

When the vehicle is turned on, these lights should come on for a few seconds and then go off. If the lights do not come on, have a Yamaha dealer check the vehicle.

### Engine trouble warning light “”

EAU73172

This warning light comes on if a problem is detected in the engine or other vehicle control system. If this occurs, have a Yamaha dealer check the on-board diagnostic system.

# Instrument and control functions

## TIP

When the vehicle is turned on, the light will come on for a few seconds and then go off. If the light does not come on, or if the light remains on, have a Yamaha dealer check the vehicle.

EAU69892

## ABS warning light “”

This warning light comes on when the vehicle is first turned on, and goes off after starting riding. If the warning light comes on while riding, the anti-lock brake system may not work correctly. (See page 4-26.)

## TIP

If the light does not come at all, or if the light does not go off after traveling 10 km/h (6 mi/h), have a Yamaha dealer check the vehicle.

EWA16041

## **WARNING**

**If the ABS warning light does not go off after traveling at a speed of 10 km/h (6 mi/h) or higher, or if the warning light comes on or flashes while riding, the brake system reverts to conventional braking. If either of the above occurs, or if the warning light does not come on at all, use extra caution to avoid possible wheel lock during emergency braking. Have a Yamaha dealer check the brake system and electrical circuits as soon as possible.**

EAU74082

## Traction control system indicator light “TCS”

This indicator light will flash when traction control has engaged.

If the traction control system is turned off, this indicator light will come on.

## TIP

When the vehicle is turned on, the light should come on for a few seconds and then go off. If the light does not come on, or if the light remains on, have a Yamaha dealer check the vehicle.

EAU55393

## Suspension system warning light “”

This warning light comes on if a problem is detected in the electronically adjustable suspension system.

## TIP

When the vehicle is turned on, the light should come on for a few seconds and then go off. If the light does not come on, or if the light remains on, have a Yamaha dealer check the vehicle.

EAU73120

## Immobilizer system indicator light “”

When the key is turned to “OFF” and 30 seconds have passed, the indicator light will flash steadily to indicate the immobilizer system is enabled. After 24 hours have passed, the indicator light will stop flashing, however the immobilizer system is still enabled.

The electrical circuit of the indicator light can be checked by turning the key to “ON”. The indicator light should come on for a few seconds, and then go off.

If the indicator light does not come on initially when the key is turned to “ON”, if the indicator light remains on, or if the indicator light flashes in a pattern (if a problem is detected in the immobilizer

# Instrument and control functions

EAU54764

system, the immobilizer system indicator light will flash in a pattern), have a Yamaha dealer check the vehicle.

## TIP

If the immobilizer system indicator light flashes in the pattern, slowly 5 times then quickly 2 times, this could be caused by transponder interference. If this occurs, try the following.

1. Make sure there are no other immobilizer keys close to the main switch. Other immobilizer system keys may cause signal interference and prevent the engine from starting.
2. Use the code re-registering key to start the engine.
3. If the engine starts, turn it off, and try starting the engine with the standard keys.
4. If one or both of the standard keys do not start the engine, take the vehicle and all 3 keys to a Yamaha dealer to have the standard keys re-registered.

## Cruise control system

This model is equipped with a cruise control system designed to maintain a set cruising speed.

The cruise control system operates only when riding in 3rd, 4th or 5th gear at speeds between about 50 km/h (31 mi/h) and 160 km/h (100 mi/h), or 6th gear at speeds between about 55 km/h (34 mi/h) and 160 km/h (100 mi/h).

EWA16341

## WARNING

- **Improper use of the cruise control system may result in loss of control, which could lead to an accident. Do not activate the cruise control system in heavy traffic, poor weather conditions, or among winding, slippery, hilly, rough or gravel roads.**
- **When traveling uphill or downhill, the cruise control system may not be able to maintain the set cruising speed.**
- **To prevent accidentally activating the cruise control system, turn it off when not in use. Make sure that the cruise control system indicator light “A line drawing of a motorcycle instrument cluster. At the top center, there is a speedometer with 'km/h' and a digital display showing '125.0'. To the left of the speedometer, there is a 'MODE' indicator. Below the speedometer, there are several indicator lights: a check engine light, a battery light, a neutral light, a headlight indicator, an ABS light, and a cruise control indicator light (1) which is a symbol of a motorcycle with a speedometer needle. To the right of the cruise control indicator light is a 'SET' indicator light (2). Further right, there are 'TCS' and 'ABS' indicator lights. On the far right, there is a digital display showing 'A.TEMP', 'C.TEMP', and 'TIME TI'.**

1. Cruise control system indicator light “

4-6

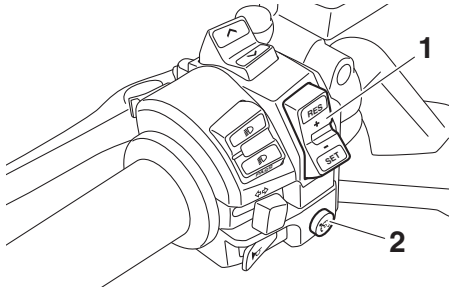

# Instrument and control functions





1. Cruise control setting switch “RES+/SET-”
2. Cruise control power switch “”

4

## Activating and setting the cruise control system

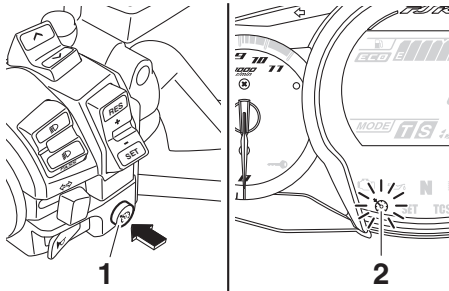
1. Push the cruise control power switch “” located on the left handlebar. The cruise control system indicator light “” will come on.



1. Cruise control power switch “”
2. Cruise control system indicator light “”

2. Push the “SET-” side of the cruise control setting switch to activate the cruise control system. Your current traveling speed will become the set cruising speed. The cruise control setting indicator light “SET” will come on.

## Adjusting the set cruising speed

While the cruise control system is operating, push the “RES+” side of the cruise control setting switch to increase the set cruising speed or the “SET-” side to decrease the set speed.

## TIP

Pushing the setting switch once will change the speed in increments of approximately 2.0 km/h (1.2 mi/h). Holding the “RES+” or “SET-” side of the cruise control setting switch down will increase or decrease the speed continuously until the switch is released.

You can also manually increase your traveling speed using the throttle. After you have accelerated, you can set a new cruising speed by pushing the “SET-” side of the setting switch. If you do not set a new cruising speed, when you return the throttle grip, the vehicle will decelerate to the previously set cruising speed.

## Deactivating the cruise control system

Perform one of the following operations to cancel the set cruising speed. The “SET” indicator light will go off.

- Turn the throttle grip past the closed position in the deceleration direction.



# Instrument and control functions

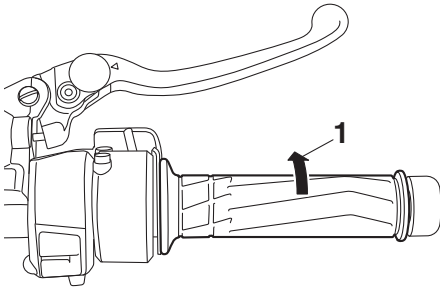

1. Deceleration direction

- Apply the front or rear brake.
- Disengage the clutch.

Push the power switch to turn off the cruise control system. The “” indicator light and the “SET” indicator light will go off.

## TIP

Traveling speed decreases as soon as the cruise control system is deactivated; unless the throttle grip is turned.

## Using the resume function

Push the “RES+” side of the cruise control setting switch to reactivate the cruise control system. The traveling speed will return to the previously set cruising speed. The “SET” indicator light will come on.

EWA16351

## WARNING

**It is dangerous to use the resume function when the previously set cruising speed is too high for current conditions.**

## TIP

Pushing the power switch while the system is operating will turn the system off completely and erase the previously



set cruising speed. You will not be able to use the resume function until a new cruising speed has been set.

## Automatic deactivation of the cruise control system

The cruise control system for this model is electronically controlled and is linked with the other control systems. The cruise control system will automatically become deactivated under the following conditions:

- The cruise control system is not able to maintain the set cruising speed.
- Wheel slip or wheel spin is detected. (If the traction control system has not been turned off, the traction control system will work.)
- The start/engine stop switch is set to the “” position.
- The engine stalls.
- The sidestand is lowered.

When traveling with a set cruising speed, if the cruise control system is deactivated under the above conditions, the “” indicator light will go off and the “SET” indicator light will flash for 4 seconds, and then go off.

When not traveling with a set cruising speed, if the start/engine stop switch is set to the “” position, the engine stalls, or the sidestand is lowered, then the “” indicator light will go off (the “SET” indicator light will not flash).

If the cruise control system is automatically deactivated, please stop and confirm that your vehicle is in good operating condition.

Before using the cruise control system again, activate it using the power switch.

# Instrument and control functions

EAU58237

## TIP

In some cases, the cruise control system may not be able to maintain the set cruising speed when the vehicle is traveling uphill or downhill.

- When the vehicle is traveling uphill, the actual traveling speed may become lower than the set cruising speed. If this occurs, accelerate to the desired traveling speed using the throttle.
- When the vehicle is traveling downhill, the actual traveling speed may become higher than the set cruising speed. If this occurs, the setting switch cannot be used to adjust the set cruising speed. To reduce the traveling speed, apply the brakes. When the brakes are applied, the cruise control system will become deactivated.

## Multi-function meter unit

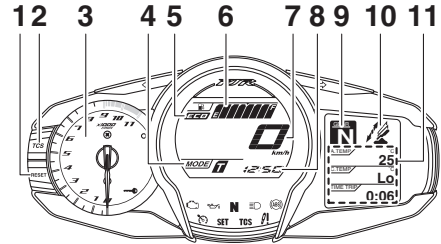

1. "RESET" button
2. "TCS" button
3. Tachometer
4. Drive mode display
5. Eco indicator "ECO"
6. Fuel meter
7. Speedometer
8. Clock
9. Transmission gear display
10. Function display
11. Information display

EWA12423

## WARNING

**Be sure to stop the vehicle before making any setting changes to the multi-function meter unit. Changing settings while riding can distract the operator and increase the risk of an accident.**

## TIP

The select switch " $\wedge/\vee$ " and the menu switch "MENU" are located on the left handlebar. These switches allow you to control or change the settings of the multi-function meter unit.

# Instrument and control functions

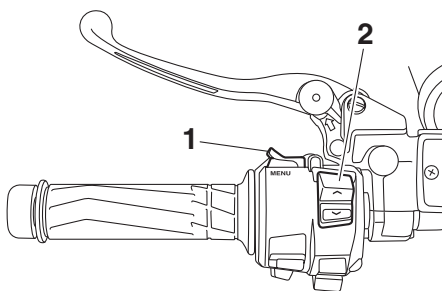

1. Menu switch “MENU”
2. Select switch “ $\wedge/\vee$ ”

The multi-function meter unit is equipped with the following:

- a speedometer
- a tachometer
- a clock
- a fuel meter
- an eco indicator
- a transmission gear display
- a drive mode display
- a function display
- an information display
- a setting mode display

## TIP

- Be sure to turn the key to “ON” before attempting to use select switch “ $\wedge/\vee$ ”, menu switch “MENU”, “RESET” button or “TCS” button.
- To switch the meter displays between kilometers and miles, see page 4-16.

## Speedometer

The speedometer shows the vehicle’s traveling speed.

## Tachometer

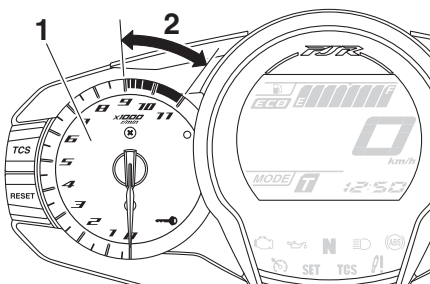

1. Tachometer
2. Tachometer red zone

The electric tachometer allows the rider to monitor the engine speed and keep it within the ideal power range. When the key is turned to “ON”, the tachometer needle sweeps across the r/min range and then returns to zero r/min in order to test the electrical circuit.

ECA10032

## NOTICE

**Do not operate the engine in the tachometer red zone.**

**Red zone: 9000 r/min and above**

## Fuel meter

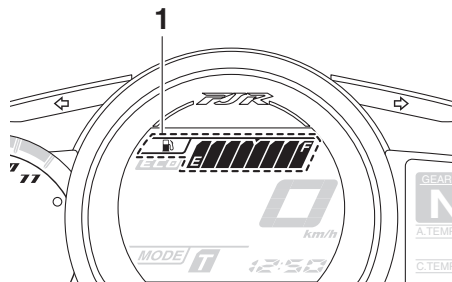

1. Fuel meter

The fuel meter indicates the amount of fuel in the fuel tank. The display segments of the fuel meter disappear from

# Instrument and control functions

“F” (full) towards “E” (empty) as the fuel level decreases. When the last segment starts flashing, refuel as soon as possible.

When the key is turned to “ON”, all display segments come on once in order to test the electrical circuit.

## TIP

If a problem is detected in the fuel meter electrical circuit, the fuel meter display segments will flash repeatedly. Have a Yamaha dealer check the vehicle.

## Eco indicator

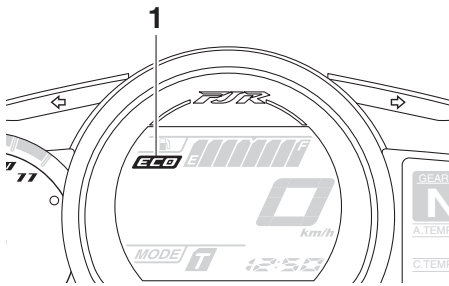

1. Eco indicator “ECO”

This indicator comes on when the vehicle is being operated in an environmentally friendly, fuel-efficient manner. The indicator goes off when the vehicle is stopped.

## TIP

Consider the following tips to reduce fuel consumption:

- Avoid high engine speeds during acceleration.
- Travel at a constant speed.
- Select the transmission gear that is appropriate for the vehicle speed.

## Transmission gear display

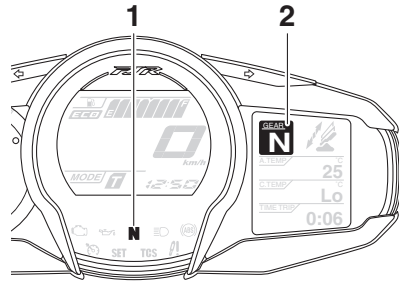

1. Neutral indicator light “N”

2. Transmission gear display

This display shows the selected gear. The neutral position is indicated by “N” and by the neutral indicator light “N”.

## Drive mode display

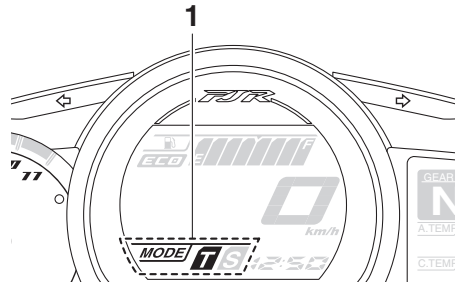

1. Drive mode display

This display indicates which drive mode has been selected: Touring mode “T” or sports mode “S”. For more details on the modes and on how to select them, see pages 4-22 and 4-23.

# Instrument and control functions

## Function display

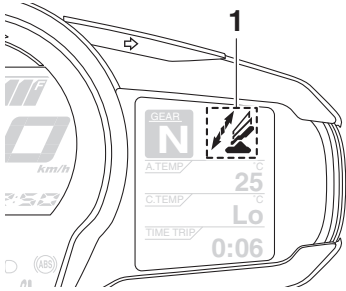

1. Function display

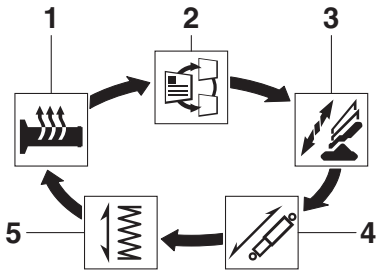

1. Grip warmer adjusting function
2. Information display selection function
3. Windshield adjusting function
4. Damping force adjusting function
5. Preload adjusting function

Push the “MENU” switch to switch the display between the following functions. The display changes each time the switch is pushed.

- Grip warmer adjusting function
- Information display selection function
- Windshield adjusting function
- Damping force adjusting function
- Preload adjusting function

## TIP

The preload adjusting function will appear only when the vehicle is stopped with the engine running.

The following pages contain an explanation of the grip warmer, information display, and windshield functions. See page 4-40 for an explanation of the preload and damping force adjusting functions.

## Adjusting the grip warmer

This vehicle is equipped with grip warmers, which can only be used when the engine is running. There are 4 grip warmer settings.

Setting	Display
Off	
Low	
Middle	
High	

To increase the grip warmer temperature, push the “^” side of the select switch. To decrease the grip warmer temperature, push the “v” side of the select switch.

ECA17932

## NOTICE

- Be sure to wear gloves when using the grip warmers.
- Do not use the grip warmers in warm weather.
- If the handlebar grip or throttle grip becomes worn or damaged, stop using the grip warmers and replace the grips.

# Instrument and control functions

## Selecting the information display

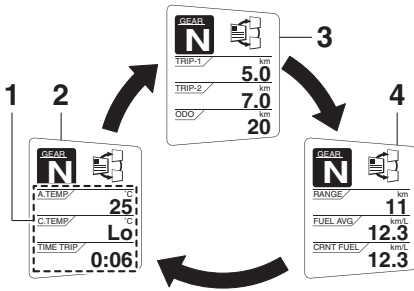

1. Information display
2. Display-1
3. Display-2
4. Display-3

There are 3 information displays. The selected information display can be switched by pushing the select switch. The following items are shown in the information displays:

- an odometer display
- tripmeter displays
- a fuel reserve tripmeter display
- an estimated traveling range display
- an elapsed time display
- an ambient temperature display
- a coolant temperature display
- an average fuel consumption display
- an instantaneous fuel consumption display

The items shown in each information display can be selected.

To set or select the items shown, see page 4-16.

## Odometer display:

ODO / km  
**20**

The odometer shows the total distance traveled by the vehicle.

## Tripmeter displays:

TRIP-1 / km  
**5.0**

TRIP-2 / km  
**7.0**

“TRIP-1” and “TRIP-2” show the distance traveled since they were last set to zero.

## TIP

- The odometer will lock at 999999.
- The tripmeters will reset and continue counting after 9999.9 is reached.

When approximately 5.5 L (1.45 US gal, 1.21 Imp.gal) of fuel remains in the fuel tank, the last segment of the fuel meter starts flashing. In addition, the information display will automatically change to the fuel reserve tripmeter mode “TRIP-F” and start counting the distance traveled from that point.

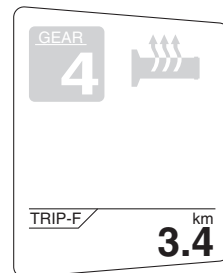

# Instrument and control functions

In this case, push the select switch to switch the display in the following order:

TRIP-F → Display-1 → Display-2 → Display-3 → TRIP-F

To reset a tripmeter, use the select switch to select the information display that contains the tripmeter you want to reset. Push the “RESET” button briefly so that the tripmeter flashes, and then push the “RESET” button again for 2 seconds while the tripmeter is flashing. If you do not reset the fuel reserve tripmeter manually, it will reset automatically after refueling and traveling 5 km (3 mi).

## Estimated traveling range display:

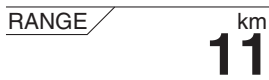

A digital display with a horizontal line above it. On the left, the word "RANGE" is written in a slanted font. On the right, the number "11" is displayed in a large font, with "km" written in a smaller font above it.

The distance that can be traveled with the remaining fuel in the fuel tank under the current riding conditions is shown.

## Elapsed time display:



A digital display with a horizontal line above it. On the left, the words "TIME TRIP" are written in a slanted font. On the right, the time "0:06" is displayed in a large font.

The time that has elapsed since the key was turned to “ON” is shown. The maximum time that can be shown is 99:59.

This timer automatically resets when the key is turned to “OFF”.

## TIP

There are also “TIME-2” and “TIME-3” elapsed time displays, but they cannot be set to the information display. See “Setting mode” on page 4-16 for detailed information.

## Ambient temperature display:

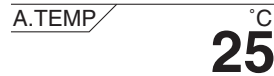

A digital display with a horizontal line above it. On the left, the words "A.TEMP" are written in a slanted font. On the right, the number "25" is displayed in a large font, with "°C" written in a smaller font above it.

This display shows the ambient temperature from  $-9^{\circ}\text{C}$  to  $50^{\circ}\text{C}$  in  $1^{\circ}\text{C}$  increments. The temperature displayed may vary from the ambient temperature.

## TIP

- $-9^{\circ}\text{C}$  will be displayed even if the ambient temperature falls below  $-9^{\circ}\text{C}$ .
- $50^{\circ}\text{C}$  will be displayed even if the ambient temperature climbs above  $50^{\circ}\text{C}$ .
- The accuracy of the temperature reading may be affected when riding under 20 km/h (12 mi/h) or when stopped at traffic signals and railroad crossings.

## Coolant temperature display:

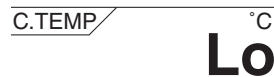

A digital display with a horizontal line above it. On the left, the words "C.TEMP" are written in a slanted font. On the right, the text "Lo" is displayed in a large font, with "°C" written in a smaller font above it.

The coolant temperature display indicates the temperature of the coolant. The coolant temperature varies with changes in the weather and engine load.

# Instrument and control functions

If the message “Hi” flashes, stop the vehicle, then stop the engine, and let the engine cool. (See page 7-38.)

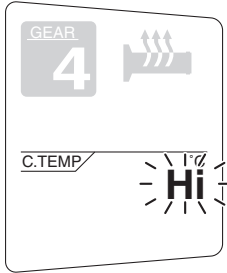

4

## TIP

The selected information display cannot be switched while the message “Hi” is flashing.

ECA10022

## NOTICE

**Do not continue to operate the engine if it is overheating.**

Average fuel consumption display:

FUEL AVG / km/L  
**12.3**

The average fuel consumption display modes “km/L”, “L/100km” or “MPG” show the average fuel consumption since the display was last reset.

- The “km/L” display shows the average distance that can be traveled on 1.0 L of fuel.
- The “L/100km” display shows the average amount of fuel necessary to travel 100 km.
- The “MPG” display shows the average distance that can be traveled on 1.0 Imp.gal of fuel.

To reset the average fuel consumption display, use the select switch to select the information display that contains the average fuel consumption display. Push the “RESET” button briefly so that the average fuel consumption display flashes, and then push the “RESET” button again for 2 seconds while the display is flashing.

## TIP

After resetting the average fuel consumption display, “\_ \_ \_” will be shown for that display until the vehicle has traveled 1 km (0.6 mi).

ECA15474

## NOTICE

**If there is a malfunction, “- - -” will be continuously displayed. Have a Yamaha dealer check the vehicle.**

Instantaneous fuel consumption display:

CRNT FUEL / km/L  
**12.3**

The instantaneous fuel consumption display modes “km/L”, “L/100km” or “MPG” show the fuel consumption under the current riding conditions.

- The “km/L” display shows the distance that can be traveled on 1.0 L of fuel.
- The “L/100km” display shows the amount of fuel necessary to travel 100 km.
- The “MPG” display shows the distance that can be traveled on 1.0 Imp.gal of fuel.



# Instrument and control functions

## TIP

If traveling at speeds under 10 km/h (6 mi/h), “\_ \_ \_” will be displayed.

ECA15474

## NOTICE

**If there is a malfunction, “- \_-” will be continuously displayed. Have a Yamaha dealer check the vehicle.**

## Adjusting the windshield position

To move the windshield up, push the “^” side of the select switch. To move the windshield down, push the “v” side of the select switch.

## Setting mode

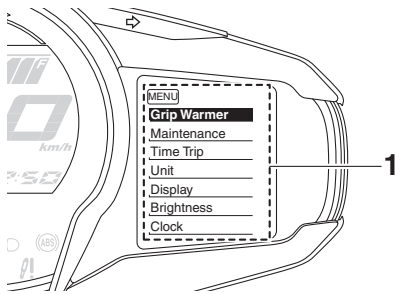

1. Setting mode display

## TIP

- The transmission must be in neutral and the vehicle must be stopped to change settings in this mode.
- Shifting the transmission into gear and starting off, or turning the key to “OFF”, saves all settings made, then exits the setting mode.

Push and hold the menu switch “MENU” for 2 seconds to enter the setting mode. To exit the setting mode

and return to the normal display, push and hold the menu switch “MENU” again for at least 2 seconds.

Display	Description
Grip Warmer	This function allows you to set the low, middle, and high settings to 10 temperature levels.
Maintenance	This function allows you to check and reset the “OIL” oil change interval (distance traveled), and the “FREE-1” and “FREE-2” maintenance intervals.
Time Trip	This function allows you to check and reset the “TIME-2” and “TIME-3” functions. These time trips show the total elapsed time that the key has been in the “ON” position. When the key is turned to “OFF”, the time trips stop counting but are not reset. The maximum time that can be shown is 99:59. When the time trips reach 99:59, they automatically reset to 0:00 and continue counting.
Unit	This function allows you to switch the display units between kilometers and miles. When kilometers are selected, the fuel consumption units can be switched between “L/100km” and “km/L”.
Display	This function allows you to change the items shown in 3 information displays.
Brightness	This function allows you to adjust the brightness of the multi-function meter unit panel to suit the outside lighting conditions.
Clock	This function allows you to set the clock.
All Reset	This function allows you to reset all items, except the odometer and the clock.

# Instrument and control functions

## Adjusting the temperature levels of the grip warmer settings

1. Use the select switch to highlight “Grip Warmer”.

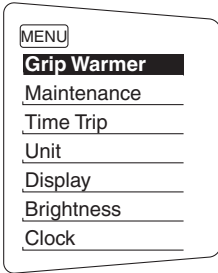

2. Push the “MENU” switch. The grip warmer setting display will be shown and “High” will flash in the display.

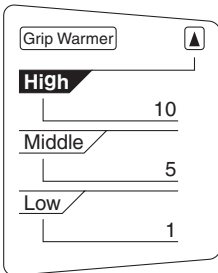

3. Push the “MENU” switch. The temperature level for the high setting will start flashing. Use the select switch to set the temperature level, and then push the “MENU” switch. “High” will start flashing.

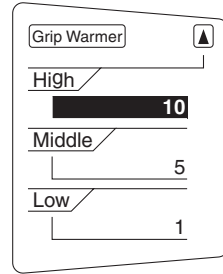

4. Use the select switch to highlight “Middle” or “Low”, and then change the setting using the same procedure that was used for the high setting.
5. When you are finished changing the settings, use the select switch to highlight “

A screenshot of the instrument's display. At the top, it says 'Grip Warmer'. Below that, the word 'High' is flashing. Underneath, there are three options: 'High' with a value of 10, 'Middle' with a value of 5, and 'Low' with a value of 1. The 'High' option is currently selected.

### **TIP**

The setting can be set to 10 temperature levels.

### Resetting the maintenance counters

1. Use the select switch to highlight “Maintenance”.

# Instrument and control functions



2. Push the “MENU” switch, and then push the “RESET” button to select the item to reset.

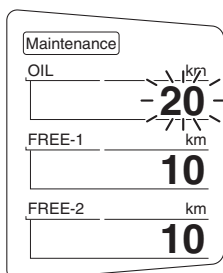

3. While the selected item is flashing, push the “RESET” button for at least 2 seconds.
4. Push the “MENU” switch to return to the setting mode menu.

## Checking and resetting “TIME-2” and “TIME-3”

1. Use the select switch to highlight “Time Trip”.

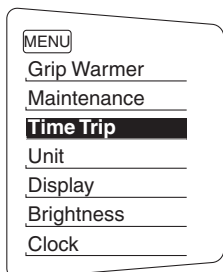

2. Push the “MENU” switch to display “TIME-2” and “TIME-3”. To reset a time trip, push the “RESET” button to select the item to reset.

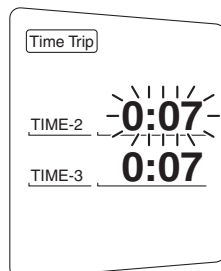

3. While the selected item is flashing, push the “RESET” button for at least 2 seconds.
4. Push the “MENU” switch to return to the setting mode menu.

## Selecting the units

1. Use the select switch to highlight “Unit”.

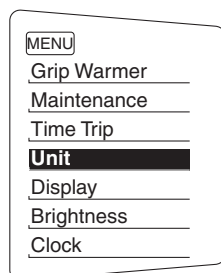

2. Push the “MENU” switch. The unit setting display will be shown and “km or mile” will flash in the display.

# Instrument and control functions

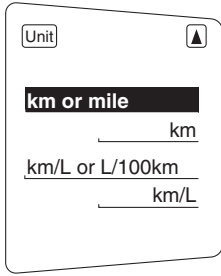

3. Push the “MENU” switch. “km” or “mile” will flash in the display.

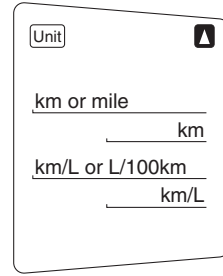

## Selecting the display items

1. Use the select switch to highlight “Display”.

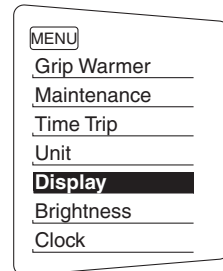

4. Use the select switch to select “km” or “mile”, and then push the “MENU” switch.

2. Push the “MENU” switch, use the select switch to highlight the display to change, and then push the “MENU” switch again.

## TIP

When “km” is selected, “L/100km” or “km/L” can be set as the fuel consumption units. To set the fuel consumption units, proceed as follows. If “mile” was selected, skip steps 5 and 6.

5. Use the select switch to select “km/L or L/100km”.
6. Push the “MENU” switch, use the select switch to select “L/100km” or “km/L”, and then push the “MENU” switch again.
7. Use the select switch to highlight “”, and then push the “MENU” switch to return to the setting mode menu.

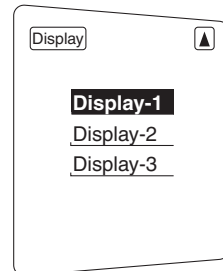

3. Use the select switch to highlight the item to change, and then push the “MENU” switch.

# Instrument and control functions

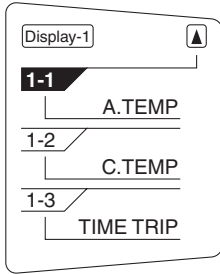

4. Use the select switch to select the item to show, and then push the "MENU" switch.

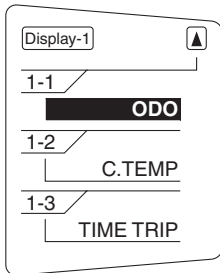

5. When you are finished changing the settings, use the select switch to highlight "A", and then push the "MENU" switch to return to the previous display.

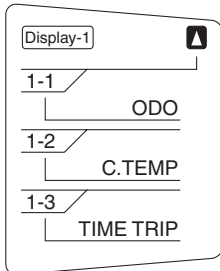

6. Use the select switch to highlight "A", and then push the "MENU" switch to return to the setting mode menu.

## Adjusting the meter panel brightness

1. Use the select switch to highlight "Brightness".

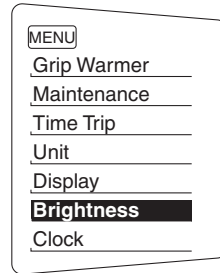

2. Push the "MENU" switch.
3. Use the select switch to select the desired brightness level, and then push the "MENU" switch to return to the setting mode menu.

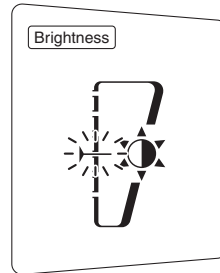

## Setting the clock

1. Use the select switch to highlight "Clock".

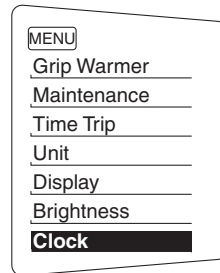

2. Push the "MENU" switch.

# Instrument and control functions

- When the hour digits start flashing, use the select switch to set the hours.

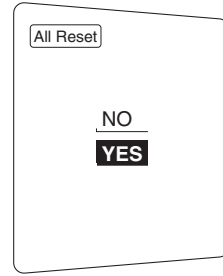
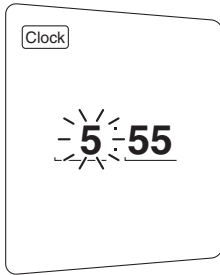

## TIP

The odometer and the clock cannot be reset.

- Push the "MENU" switch, and the minute digits start flashing.
- Use the select switch to set the minutes.
- Push the "MENU" switch to return to the setting mode menu.

## Resetting all of the display items

- Use the select switch to highlight "All Reset".

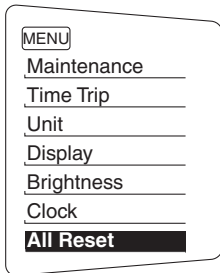

- Push the "MENU" switch.
- Use the select switch to highlight "YES", and then push the "MENU" switch.

## D-mode (drive mode)

D-mode is an electronically controlled engine performance system with two mode selections (touring mode “T” and sports mode “S”).

Push the drive mode switch “MODE” to switch between modes. (See page 4-23 for an explanation of the drive mode switch.)

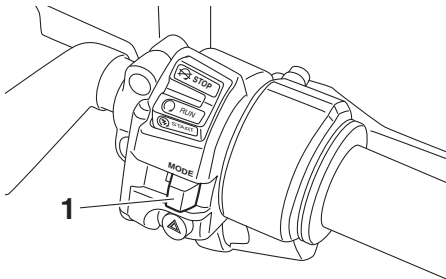

1. Drive mode switch “MODE”

### TIP

Before using D-mode, make sure you understand its operation along with the operation of the drive mode switch.

## Touring mode “T”

The touring mode “T” is suitable for various riding conditions.

This mode allows the rider to enjoy smooth drivability from the low-speed range to the high-speed range.

## Sports mode “S”

This mode offers a sportier engine response in the low- to mid-speed range compared to the touring mode.

## Handlebar switches

### Left

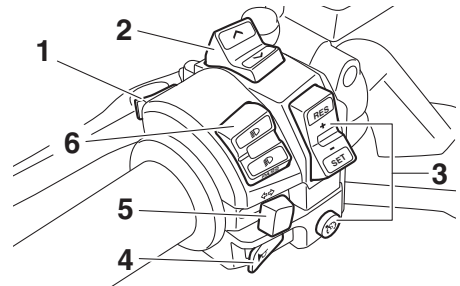

1. Menu switch “MENU”
2. Select switch “ $\wedge/\vee$ ”
3. Cruise control switches
4. Horn switch “ $\text{📢}$ ”
5. Turn signal switch “ $\leftarrow/\rightarrow$ ”
6. Dimmer/Pass switch “ $\text{☰}/\text{☷}/\text{PASS}$ ”

### Right

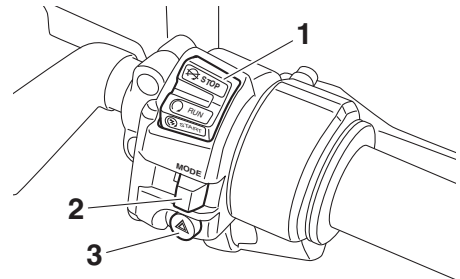

1. Stop/Run/Start switch “ $\text{⊗}/\text{○}/\text{⊕}$ ”
2. Drive mode switch “MODE”
3. Hazard switch “ $\text{⚠}$ ”

## Dimmer/Pass switch “ $\text{☰}/\text{☷}/\text{PASS}$ ”

EAU73022

Set this switch to “ $\text{☰}$ ” for the high beam and to “ $\text{☷}$ ” for the low beam. To flash the high beam, push the switch down towards “PASS”.

### TIP



Both headlights come on whether set to high beam or low beam.

# Instrument and control functions

## Turn signal switch “/”

EAU12461

ECA10062

To signal a right-hand turn, push this switch to “”. To signal a left-hand turn, push this switch to “”. When released, the switch returns to the center position. To cancel the turn signal lights, push the switch in after it has returned to the center position.



## Horn switch “”

EAU12501

Press this switch to sound the horn.

## Stop/Run/Start switch “/”

EAU54212

To crank the engine with the starter, set this switch to “”, and then push the switch down towards “”. See page 6-2 for starting instructions prior to starting the engine.

Set this switch to “” to stop the engine in case of an emergency, such as when the vehicle overturns or when the throttle cable is stuck.

## Hazard switch “”

EAU12735

With the key in the “ON” or “P<” position, use this switch to turn on the hazard lights (simultaneous flashing of all turn signal lights).

The hazard lights are used in case of an emergency or to warn other drivers when your vehicle is stopped where it might be a traffic hazard.

## NOTICE

**Do not use the hazard lights for an extended length of time with the engine not running, otherwise the battery may discharge.**

## Cruise control switches

EAU12781

See page 4-6 for an explanation of the cruise control system.

## Menu switch “MENU”

EAU54232

This switch is used to make setting changes within the multi-function meter unit. (See page 4-9.)

## Select switch “/”

EAU54222

This switch is used to make setting changes within the multi-function meter unit. (See page 4-9.)

## Drive mode switch “MODE”

EAU54691

EWA15341

## WARNING

**Do not change the D-mode while the vehicle is moving.**

Using this switch changes the drive mode to touring mode “T” or sports mode “S”.

The throttle grip must be completely closed in order to change the drive mode.

The selected mode is shown on the drive mode display. (See page 4-11.)

The drive mode cannot be changed while the cruise control system is operating.



## Clutch lever

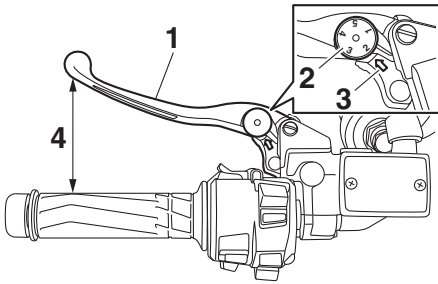

1. Clutch lever
2. Clutch lever position adjusting dial
3. Match mark
4. Distance

The clutch lever is located on the left side of the handlebar. Pull the clutch lever to disengage the engine from the drivetrain. Release the lever to engage the clutch and transmit power to the rear wheel.

### TIP

- The lever should be pulled rapidly and released slowly for smooth shifting. (See page 6-3.)
- The clutch lever is equipped with a switch, which is part of the ignition circuit cut-off system. (See page 4-46.)

The position of the clutch lever can be adjusted. To adjust the distance between the clutch lever and the handlebar, gently push the lever away from the handlebar and rotate the position adjusting dial.

### TIP

Make sure the setting number on the position adjusting dial aligns with the match mark.

## Shift pedal

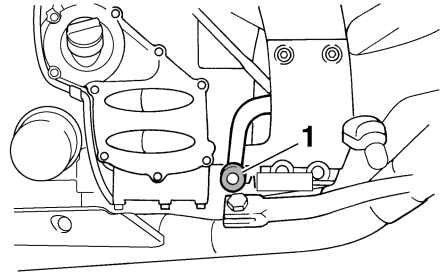

1. Shift pedal

The shift pedal is located on the left side of the motorcycle. To shift the transmission to a higher gear, move the shift pedal up. To shift the transmission to a lower gear, move the shift pedal down. (See page 6-3.)

# Instrument and control functions

EAU26826

## Brake lever

The brake lever is located on the right side of the handlebar. To apply the front brake, pull the lever toward the throttle grip.

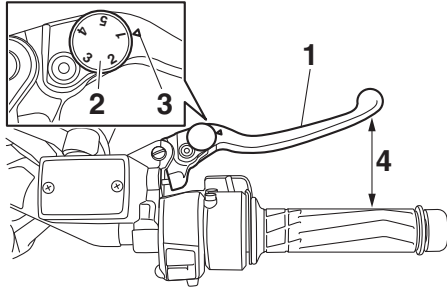

1. Brake lever
2. Brake lever position adjusting dial
3. Match mark
4. Distance

The brake lever is equipped with a brake lever position adjusting dial. To adjust the distance between the brake lever and the throttle grip, slightly pull the brake lever away from the throttle grip and rotate the adjusting dial. Make sure the setting number on the adjusting dial aligns with the match mark on the brake lever.

EAU39542

## Brake pedal

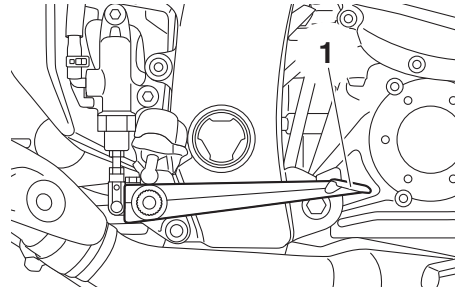

1. Brake pedal

The brake pedal is located on the right side of the vehicle.

This model is equipped with a unified brake system.

When pressing down on the brake pedal, the rear brake and a portion of the front brake are applied. For full braking performance, apply both the brake lever and the brake pedal simultaneously.

# Instrument and control functions

EAU73181

## ABS

This model's anti-lock brake system (ABS) features a dual electronic control system, which acts on the front and rear brakes independently.

Operate the brakes with ABS as you would conventional brakes. If the ABS is activated, a pulsating sensation may be felt at the brake lever or brake pedal. In this situation, continue to apply the brakes and let the ABS work; do not "pump" the brakes as this will reduce braking effectiveness.

EWA16051

### **WARNING**

Always keep a sufficient distance from the vehicle ahead to match the riding speed even with ABS.

- The ABS performs best with long braking distances.
- On certain surfaces, such as rough or gravel roads, the braking distance may be longer with the ABS than without.

The ABS is monitored by an ECU, which will revert the system to conventional braking if a malfunction occurs.

### **TIP**

- The ABS performs a self-diagnosis test each time the vehicle first starts off after the key is turned to "ON" and the vehicle has traveled at a speed of 10 km/h (6 mi/h) or higher. During this test, a "clicking" noise may be heard from the hydraulic control unit, and if the brake lever or brake pedal is even slightly applied, a vibration can be felt at the lever and pedal, but this does not indicate a malfunction.

- This ABS has a test mode which allows the owner to experience the pulsation at the brake lever or brake pedal when the ABS is operating. However, special tools are required, so please consult your Yamaha dealer.

ECA16831

### **NOTICE**

Keep any type of magnets (including magnetic pick-up tools, magnetic screwdrivers, etc.) away from the front and rear wheel hubs; otherwise, the magnetic rotors equipped in the wheel hubs may be damaged, resulting in improper performance of the ABS and the unified brake system.

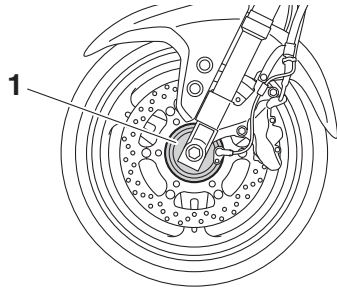

1. Front wheel hub

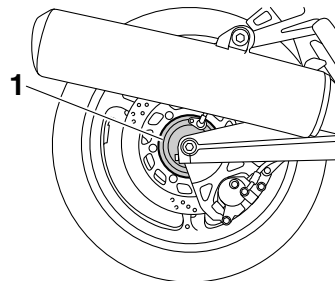

1. Rear wheel hub

# Instrument and control functions

EAU54274

## Traction control system

The traction control system helps maintain traction when accelerating on slippery surfaces, such as unpaved or wet roads. If sensors detect that the rear wheel is starting to slip (uncontrolled spinning), the traction control system assists by reducing engine power until traction is restored.

### TIP

- The TCS indicator light will flash to let you know that traction control has engaged.
- Slight changes in engine and exhaust sound may also be noticeable.

EWA15433

### WARNING

**The traction control system is not a substitute for riding appropriately for the conditions. Traction control cannot prevent loss of traction due to excessive speed when entering turns, when accelerating hard at a sharp lean angle, or while braking, and cannot prevent front wheel slipping. As with any vehicle, approach surfaces that may be slippery with caution and avoid especially slippery surfaces.**

## Turning TCS off or on

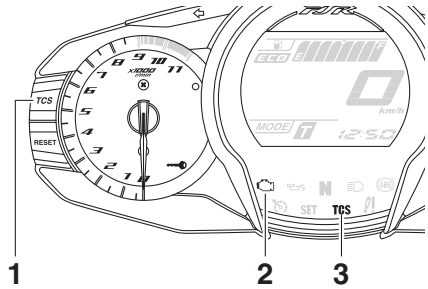

1. "TCS" button
2. Engine trouble warning light "H"
3. Traction control system indicator light "TCS"

When the vehicle is turned on, the traction control system automatically turns on.

To turn off the traction control system, stop the vehicle and push the traction control system button for 2 seconds. The TCS indicator light will come on.

To turn traction control back on, push the TCS button again. The TCS indicator light will turn off.

### TIP

Turn off traction control to help free the rear wheel if stuck in mud, sand, or other situation.

## Notes on usage

The traction control system will be disabled if:

- either wheel comes off the ground.
- excessive rear wheel spin is detected.
- either wheel is forcibly rotated (such as when performing maintenance).

**TIP**

If the traction control system is disabled, both the TCS indicator light and the engine trouble warning light will come on.

ECA16801

**NOTICE**

**Use only the specified tires. (See page 7-20.) Using different sized tires will prevent the traction control system from controlling tire rotation accurately.**

**To reset the traction control system**

1. Turn the vehicle off and wait a few seconds.
2. Turn the vehicle on and start the engine.
3. After traveling at least 20 km/h (12 mph), the TCS indicator light should turn off and the system be enabled.
4. Have a Yamaha dealer check the vehicle and turn off the engine trouble warning light.

**TIP**

If the TCS indicator light or engine trouble warning light remain on after resetting, ride cautiously and have a Yamaha dealer check the vehicle as soon as possible.

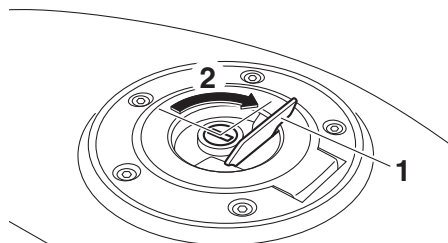
**Fuel tank cap**

1. Fuel tank cap lock cover
2. Unlock.

**To open the fuel tank cap**

Open the fuel tank cap lock cover, insert the key into the lock, and then turn it 1/4 turn clockwise. The lock will be released and the fuel tank cap can be opened.

**To close the fuel tank cap**

With the key still inserted in the lock, push down the fuel tank cap. Turn the key 1/4 turn counterclockwise, remove it, and then close the lock cover.

**TIP**

The fuel tank cap cannot be closed unless the key is in the lock. In addition, the key cannot be removed if the cap is not properly closed and locked.

EWA11092

**WARNING**

**Make sure that the fuel tank cap is properly closed after filling fuel. Leaking fuel is a fire hazard.**

# Instrument and control functions

## Fuel

EAU13222

Make sure there is sufficient gasoline in the tank.

EWA10882

### **! WARNING**

**Gasoline and gasoline vapors are extremely flammable. To avoid fires and explosions and to reduce the risk of injury when refueling, follow these instructions.**

1. Before refueling, turn off the engine and be sure that no one is sitting on the vehicle. Never refuel while smoking, or while in the vicinity of sparks, open flames, or other sources of ignition such as the pilot lights of water heaters and clothes dryers.
2. Do not overfill the fuel tank. When refueling, be sure to insert the pump nozzle into the fuel tank filler hole. Stop filling when the fuel reaches the bottom of the filler tube. Because fuel expands when it heats up, heat from the engine or the sun can cause fuel to spill out of the fuel tank.

4

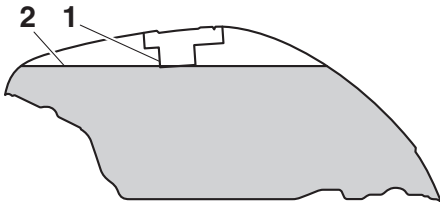

1. Fuel tank filler tube
2. Maximum fuel level

3. Wipe up any spilled fuel immediately. **NOTICE:** Immediately wipe off spilled fuel with a clean, dry, soft cloth, since fuel may deteriorate painted surfaces or plastic parts. [ECA10072]
4. Be sure to securely close the fuel tank cap.

EWA15152

### **! WARNING**

**Gasoline is poisonous and can cause injury or death. Handle gasoline with care. Never siphon gasoline by mouth. If you should swallow some gasoline or inhale a lot of gasoline vapor, or get some gasoline in your eyes, see your doctor immediately. If gasoline spills on your skin, wash with soap and water. If gasoline spills on your clothing, change your clothes.**

EAU13315

#### **Recommended fuel:**

Regular unleaded gasoline (Gasohol [E10] acceptable)

#### **Fuel tank capacity:**

25 L (6.6 US gal, 5.5 Imp.gal)

#### **Fuel reserve amount:**

5.5 L (1.45 US gal, 1.21 Imp.gal)

ECA11401

### **NOTICE**

**Use only unleaded gasoline. The use of leaded gasoline will cause severe damage to internal engine parts, such as the valves and piston rings, as well as to the exhaust system.**

Your Yamaha engine has been designed to use regular unleaded gasoline with a pump octane number

[(R+M)/2] of 86 or higher, or a research octane number of 91 or higher. If knocking (or pinging) occurs, use a gasoline of a different brand or premium unleaded fuel. Use of unleaded fuel will extend spark plug life and reduce maintenance costs.

## Gasohol

There are two types of gasohol: gasohol containing ethanol and that containing methanol. Gasohol containing ethanol can be used if the ethanol content does not exceed 10% (E10). Gasohol containing methanol is not recommended by Yamaha because it can cause damage to the fuel system or vehicle performance problems.

## Fuel tank breather/overflow hose

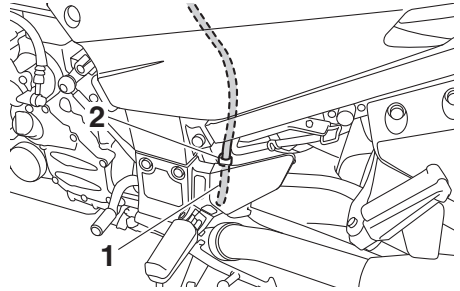

1. Fuel tank breather/overflow hose
2. Clamp

Before operating the motorcycle:

- Check the fuel tank breather/overflow hose connection.
- Check the fuel tank breather/overflow hose for cracks or damage, and replace it if necessary.
- Make sure that the end of the fuel tank breather/overflow hose is not blocked, and clean it if necessary.
- Make sure that the fuel tank breather/overflow hose is routed through the clamp.

# Instrument and control functions

EAU13447

EAU39496

## Catalytic converters

This vehicle is equipped with catalytic converters in the exhaust system.

EWA10863

### **WARNING**

The exhaust system is hot after operation. To prevent a fire hazard or burns:

- Do not park the vehicle near possible fire hazards such as grass or other materials that easily burn.
- Park the vehicle in a place where pedestrians or children are not likely to touch the hot exhaust system.
- Make sure that the exhaust system has cooled down before doing any maintenance work.
- Do not allow the engine to idle more than a few minutes. Long idling can cause a build-up of heat.

ECA10702

### **NOTICE**

Use only unleaded gasoline. The use of leaded gasoline will cause unreparable damage to the catalytic converter.

## Seats

### Passenger seat

#### To remove the passenger seat

1. Insert the key into the seat lock, and then turn it counterclockwise.

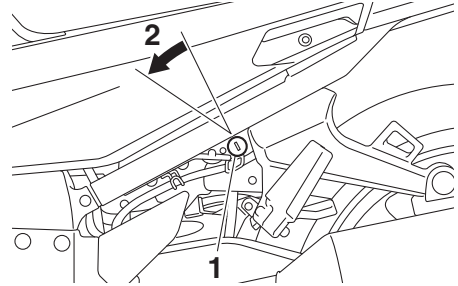

1. Seat lock
2. Unlock.

2. Lift the front of the passenger seat and pull it forward.

#### To install the passenger seat

1. Insert the projections on the rear of the passenger seat into the seat holders as shown, and then push the front of the seat down to lock it in place.

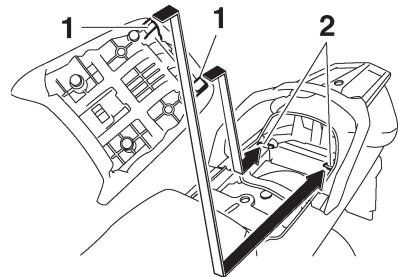

1. Projection
2. Seat holder

2. Remove the key.



# Instrument and control functions

## Rider seat

- The rider seat height can be adjusted to change the riding position. (See the following section.)

### To remove the rider seat

1. Remove the passenger seat.
2. Push the rider seat lock lever, located under the back of the rider seat, to the left as shown, and then pull the seat off.

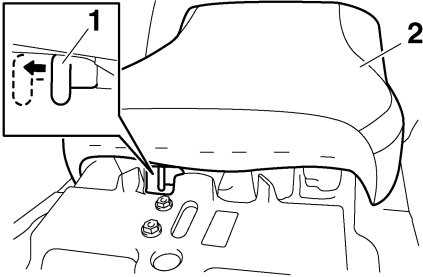

1. Rider seat lock lever
2. Rider seat

### To install the rider seat

1. Insert the projection on the front of the rider seat into the seat holder as shown, and then push the rear of the seat down to lock it in place.

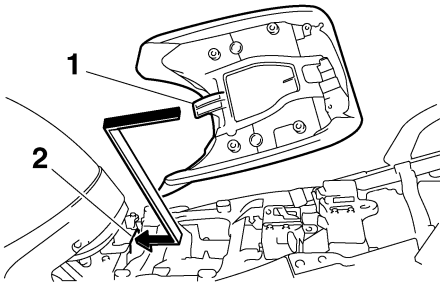

1. Projection
2. Seat holder

2. Install the passenger seat.

### TIP

- Make sure that the seats are properly secured before riding.

# Instrument and control functions

EAU39633

## Adjusting the rider seat height

The rider seat height can be adjusted to one of two positions to suit the rider's preference.

The rider seat height was adjusted to the lower position at delivery.

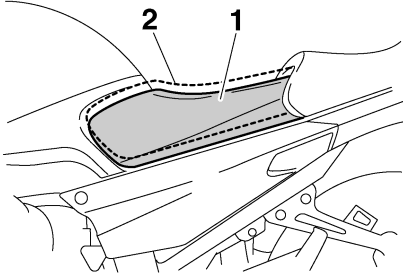

1. Low position
2. High position

## To change the rider seat height to the high position

1. Remove the rider seat. (See page 4-31.)
2. Remove the rider seat height position adjuster by pulling it upward.

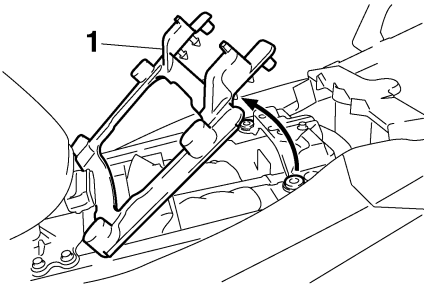

1. Rider seat height position adjuster

3. Move the rider seat holder cover to the lower position as shown.

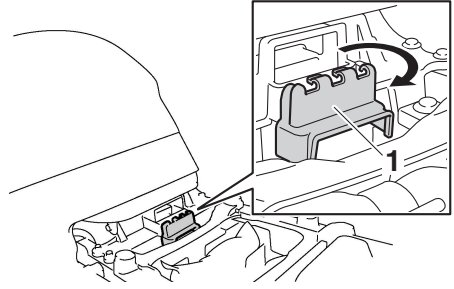

1. Rider seat holder cover

4. Install the rider seat height position adjuster so that the "H" mark is aligned with the match mark.

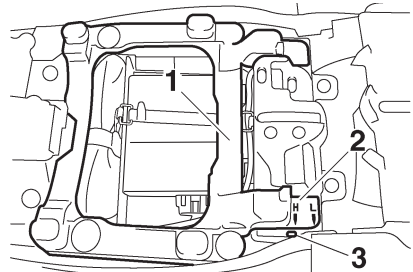

1. Rider seat height position adjuster
2. "H" mark
3. Match mark

5. Insert the projection on the front of the rider seat into seat holder B as shown.

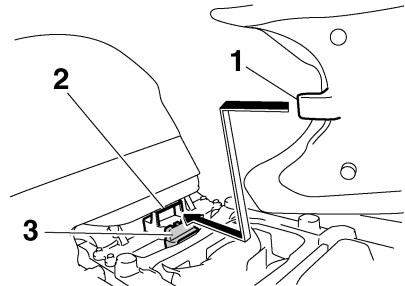

1. Projection
2. Seat holder B (for high position)
3. Rider seat holder cover

# Instrument and control functions

6. Align the projection on the bottom of the rider seat with the “H” position slot, and then push the rear of the seat down to lock it in place as shown.

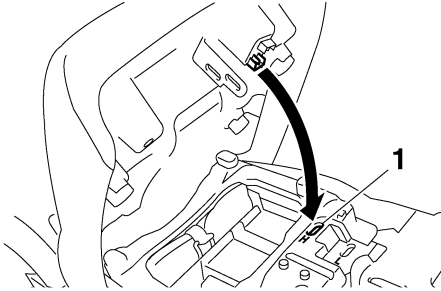

1. “H” position slot

7. Install the passenger seat.

## To change the rider seat height to the low position

1. Remove the rider seat. (See page 4-31.)
2. Remove the rider seat height position adjuster by pulling it upward.
3. Move the rider seat holder cover to the upper position.
4. Install the rider seat height position adjuster so that the “L” mark is aligned with the match mark.

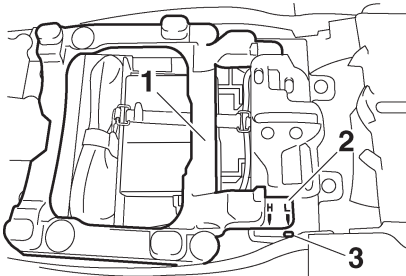

1. Rider seat height position adjuster  
2. “L” mark  
3. Match mark

5. Insert the projection on the front of the rider seat into seat holder A as shown.

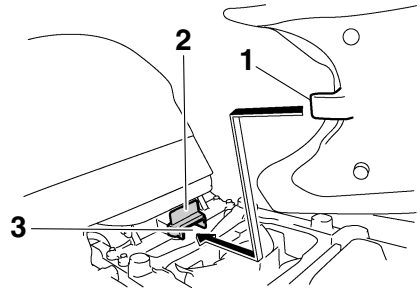

1. Projection  
2. Rider seat holder cover  
3. Seat holder A (for low position)

6. Align the projection on the bottom of the rider seat with the “L” position slot, and then push the rear of the seat down to lock it in place as shown.

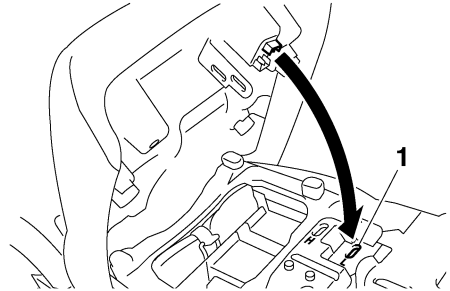

1. “L” position slot

7. Install the passenger seat.

## TIP

Make sure that the seats are properly secured before riding.

# Instrument and control functions

EAU73350

## Storage compartments

This vehicle is equipped with two storage compartments.

Storage compartment A is located under the rider seat. (See page 4-31.)

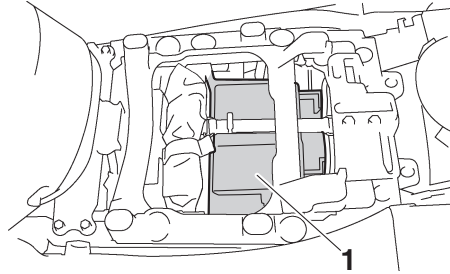

1. Storage compartment A

Storage compartment B is located under the passenger seat. (See page 4-31.)

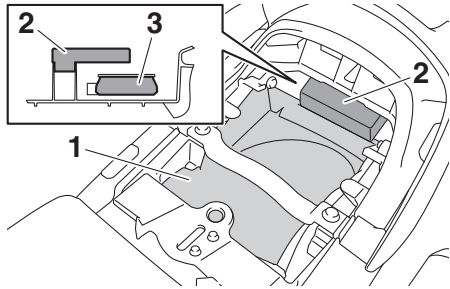

1. Storage compartment B
2. Protective cover
3. Inertial measurement unit (IMU)

ECA23290

## NOTICE

The IMU is not user serviceable and very sensitive, so we advise against removing the protective cover, placing any foreign materials near the IMU, or handling the IMU directly.

- Do not move or remount the IMU to a different location.

- Do not subject the IMU to strong shocks or moisture.
- Do not obstruct the IMU breather hole and do not clean it with compressed air.

When storing documents or other items in a storage compartment, be sure to wrap them in a plastic bag so that they will not get wet. When washing the vehicle, be careful not to let any water enter a storage compartment.

EWA14421

## WARNING

- Do not exceed the load limit of 1 kg (2 lb) for storage compartment A.
- Do not exceed the load limit of 3 kg (7 lb) for storage compartment B.
- Do not exceed the maximum load of 213 kg (470 lb) for the vehicle.

# Instrument and control functions

## Accessory box

EAU39482

The accessory box is located beside the meter panel.

- Do not exceed the maximum load of 213 kg (470 lb) for the vehicle.

### To open the accessory box

1. Insert the key into the main switch, and then turn it to “ON”.
2. Push the accessory box button, and then open the accessory box lid.

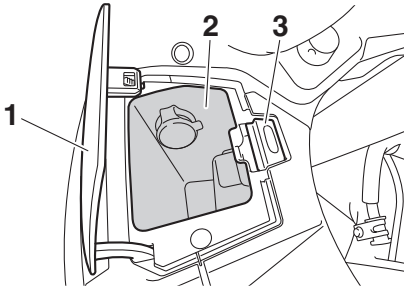

1. Accessory box lid
2. Accessory box
3. Accessory box button

3. Turn the key to “OFF” to preserve the battery.

### To close the accessory box

1. Fold the accessory box lid down.
2. Remove the key.

ECA11802

### NOTICE

**Do not place heat-sensitive items in the accessory box. The accessory box can get hot when the engine is running or the vehicle is in direct sunlight.**

EWA11422

### WARNING

- Do not exceed the load limit of 0.3 kg (0.66 lb) for the accessory box.

# Instrument and control functions

EAU39612

EAU39642

## Adjusting the headlight beams

The headlight beam adjusting knobs are used to raise or lower the height of the headlight beams. It may be necessary to adjust the headlight beams to increase visibility and help prevent blinding oncoming drivers when carrying more or less load than usual. Obey local laws and regulations when adjusting the headlights.

To raise the headlight beams, turn the knobs in direction (a). To lower the headlight beams, turn the knobs in direction (b).

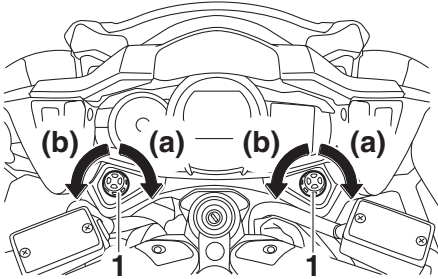

1. Headlight beam adjusting knob

## Handlebar position

The handlebars can be adjusted to one of three positions to suit the rider's preference. Have a Yamaha dealer adjust the position of the handlebars.

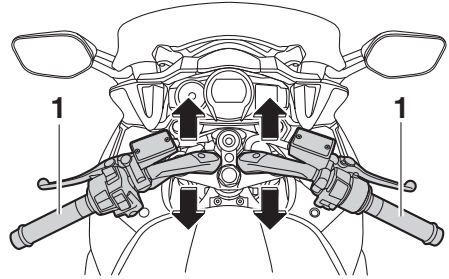

1. Handlebar

EAU54151

## Opening and closing the cowling vents

The cowling vents can be opened 20 mm (0.79 in) for added ventilation to suit the riding conditions.

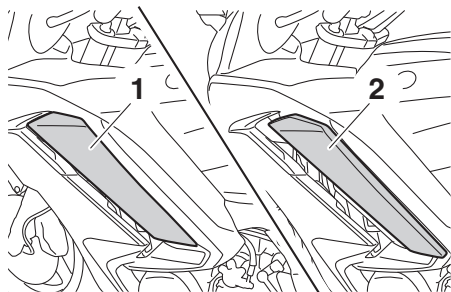

1. Closed position
2. Open position

### To open a cowling vent

1. Remove the quick fastener.
2. Slide the cowling vent panel forward to unhook its projections from the lower slots, and then pull the panel off.

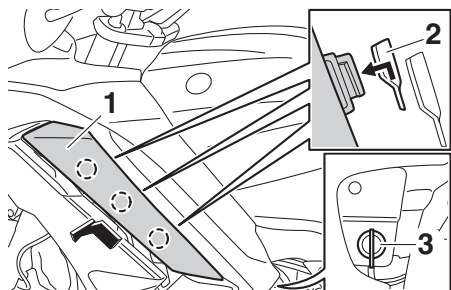

1. Cowling vent panel
2. Lower slot
3. Quick fastener

3. Insert the projections into the upper slots, and then slide the panel backward.

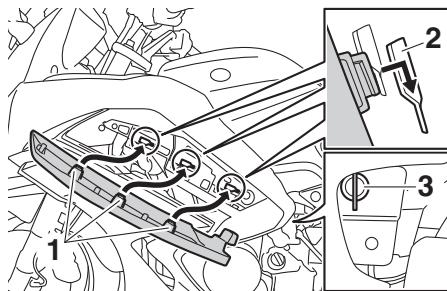

1. Projection
2. Upper slot
3. Quick fastener

4. Install the quick fastener.

### To close a cowling vent

1. Remove the quick fastener.
2. Slide the cowling vent panel forward to unhook its projections from the upper slots, and then pull the panel off.

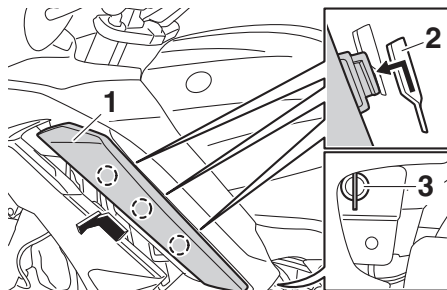

1. Cowling vent panel
2. Upper slot
3. Quick fastener

3. Insert the projections into the lower slots, and then slide the panel backward.

# Instrument and control functions

EAU39672

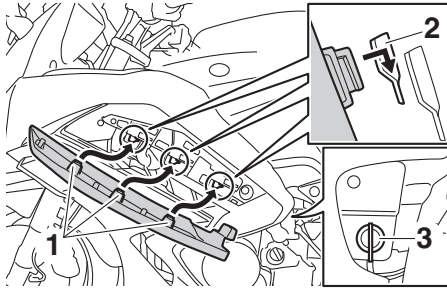

1. Projection
2. Lower slot
3. Quick fastener

4. Install the quick fastener.

## TIP

Make sure that the cowling vent panels are properly installed before riding.

## Rear view mirrors

The rear view mirrors of this vehicle can be folded forward or backward for parking in narrow spaces. Fold the mirrors back to their original position before riding.

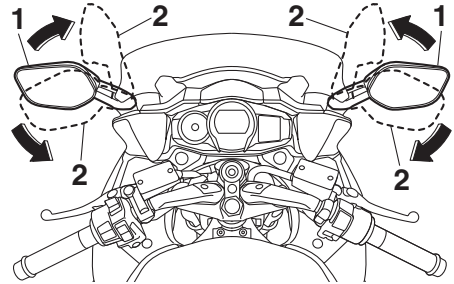

1. Riding position
2. Parking position

EWA14372

## WARNING

Be sure to fold the rear view mirrors back to their original position before riding.



# Instrument and control functions

EAU55425

## Adjusting the front and rear suspension

This model is equipped with an electronically adjustable suspension system. The preload of the rear shock absorber and the damping forces of both the front fork and rear shock absorber can be adjusted.

EWA12423



**Be sure to stop the vehicle before making any setting changes to the multi-function meter unit. Changing settings while riding can distract the operator and increase the risk of an accident.**

### Preload

When riding with luggage or a passenger, use the preload adjusting function to adjust the suspension system to match the load. There are 4 preload settings.

### TIP

- The preload adjusting function will appear only when the engine is running.
- Changing the preload setting will also adjust the front and rear suspension damping forces accordingly. (See page 4-42.)
- About cold temperature operation:
  - When using the preload adjusting function, there should be no weight on the vehicle.
  - When using the preload adjusting function at ambient temperatures near or below 0 °C (32 °F), the suspension system warning light may come on.

- The suspension will still operate as normal, only the preload adjusting function cannot be used.
- To reset the suspension system warning light, wait approximately 6 minutes and then turn the main switch off or immediately turn the main switch off and then wait 6 minutes.
- If the suspension system warning light remains on, have a Yamaha dealer check the vehicle.

### To adjust the preload

1. Turn the main switch on, start the engine, and then shift the transmission into neutral.
2. Push the menu switch to switch the function display to the preload adjusting function.

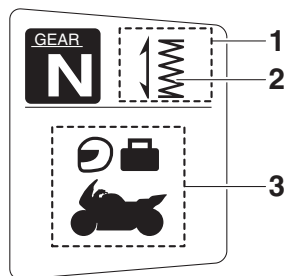

1. Function display
2. Preload adjusting function
3. Preload setting pictogram

# Instrument and control functions

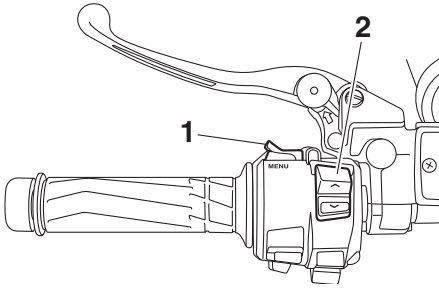

1. Menu switch "MENU"
2. Select switch "▲/▼"
3. Use the select switch to select the desired preload pictogram. Select the suitable setting from the following 4 pictograms according to your load condition.

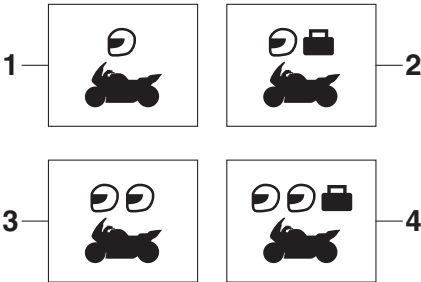

1. Solo riding
2. Solo riding and luggage
3. Passenger riding
4. Passenger riding and luggage

While the preload is being adjusted, the information display will show a group of dots moving in a circle. Once the selected pictogram returns, the preload adjustment is complete.

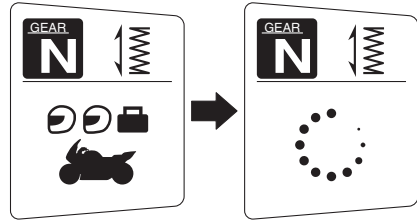

While the preload is being adjusted, the information display may change as follows.

- If the main switch is turned off or the engine is stopped while the preload is being set, the following preload setting pictogram will flash to alert you that the current preload setting does not match the pictogram. If this occurs, adjust the preload again.

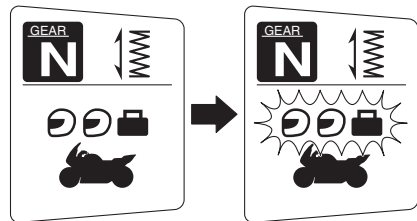

- If the vehicle starts moving, the following preload setting pictogram will flash to alert you that the current preload setting does not match the pictogram. If this occurs, stop the vehicle and adjust the preload again.

# Instrument and control functions

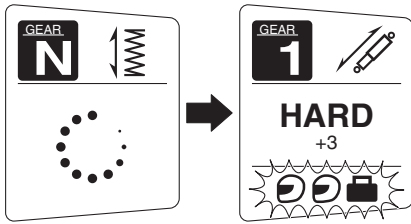

- If the preload is adjusted repeatedly, the preload setting pictogram will flash 4 times and the preload cannot be adjusted. Wait approximately 6 minutes for the preload adjusting function motor to cool down, and then try adjusting the preload again.

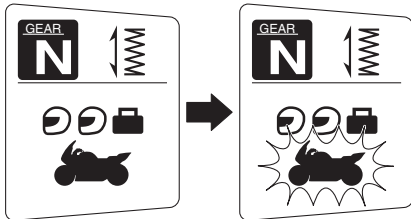

## Damping force

Within each preload setting there are 3 damping force settings: “HARD” (hard), “STD” (standard) and “SOFT” (soft). When the preload setting is changed, the damping force settings will change accordingly. (The electronically adjustable suspension system will automatically adjust to the damping force settings last set for that preload setting.) To further finely adjust the damping force, each damping force setting can be set to 7 different levels.

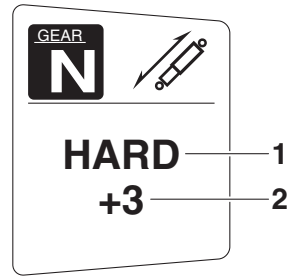

1. Damping force setting
2. Damping force setting level

## TIP

If the preload setting was not completed correctly:

- The damping force setting and setting level will flash 4 times and cannot be adjusted if you try to adjust them while the vehicle is stopped.
- The preload setting pictogram will flash and the damping force cannot be adjusted if you try to adjust it while the vehicle is moving.

Be sure that the preload has been set correctly before adjusting the damping force.

## To adjust the damping force and damping force setting level

1. Turn the main switch on.
2. Push the menu switch to switch the function display to the damping force adjusting function.

# Instrument and control functions

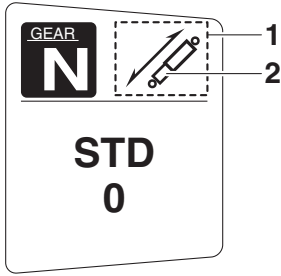

1. Function display
2. Damping force adjusting function
3. Use the select switch to select “HARD”, “STD” or “SOFT”.

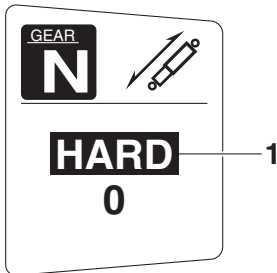

1. Damping force setting
4. Push the menu switch.
5. Use the select switch to select the desired level for the damping force setting.

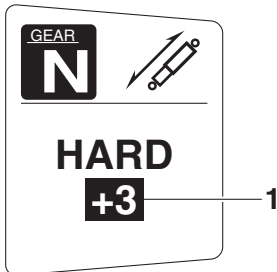

1. Damping force setting level

## TIP

The damping force setting can be set to 7 levels (+3, +2, +1, 0, -1, -2 and -3). “+3” is the hardest level and “-3” is the softest level.

6. Push the menu switch.

If the vehicle moves while you are adjusting the damping force, the information display will change to the display mode.

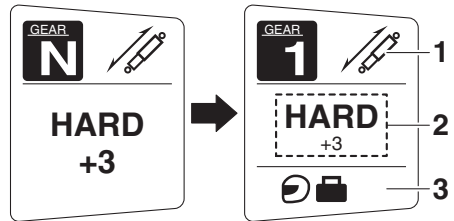

1. Damping force adjusting function
2. Damping force setting
3. Preload setting pictogram

EWA16421

## WARNING

The rear shock absorber assembly contains highly pressurized nitrogen gas. Read and understand the following information before handling the shock absorber assembly.

- Do not tamper with or attempt to open the cylinder assembly.
- Do not subject the shock absorber assembly to an open flame or other high heat source. This may cause the unit to explode due to excessive gas pressure.

# Instrument and control functions

- Do not deform or damage the cylinder in any way. Cylinder damage will result in poor damping performance.
- Do not dispose of a damaged or worn-out shock absorber assembly yourself. Take the shock absorber assembly to a Yamaha dealer for any service.

## Auxiliary DC jack

EAU39657

EWA14361

### **WARNING**

To prevent electrical shock or short-circuiting, make sure that the cap is installed when the auxiliary DC jack is not being used.

ECA15432

### **NOTICE**

The accessory connected to the auxiliary DC jack should not be used with the engine turned off, and the load must never exceed 30 W (2.5 A), otherwise the fuse may blow or the battery may discharge.

This vehicle is equipped with an auxiliary DC jack in the accessory box.

A 12-V accessory connected to the auxiliary DC jack can be used when the key is in the "ON" position and should only be used when the engine is running.

### To use the auxiliary DC jack

1. Open the accessory box lid. (See page 4-36.)
2. Turn the key to "OFF".
3. Remove the auxiliary DC jack cap.

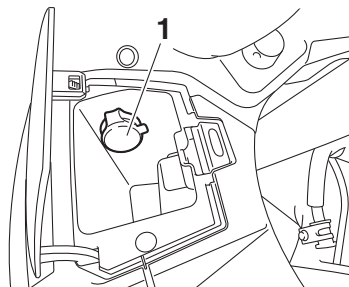

1. Auxiliary DC jack cap

4. Turn the accessory off.

# Instrument and control functions

EAU15306

5. Insert the accessory plug into the auxiliary DC jack.

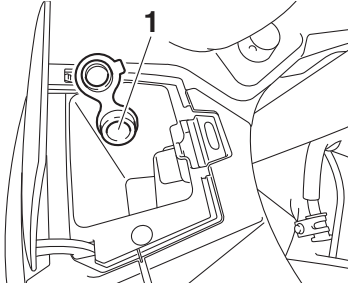

1. Auxiliary DC jack

6. Turn the key to "ON", and then start the engine. (See page 6-2.)
7. Turn the accessory on.

## Sidestand

The sidestand is located on the left side of the frame. Raise the sidestand or lower it with your foot while holding the vehicle upright.

### TIP

The built-in sidestand switch is part of the ignition circuit cut-off system, which cuts the ignition in certain situations. (See the following section for an explanation of the ignition circuit cut-off system.)

EWA10242

### **WARNING**

**The vehicle must not be ridden with the sidestand down, or if the sidestand cannot be properly moved up (or does not stay up), otherwise the sidestand could contact the ground and distract the operator, resulting in a possible loss of control. Yamaha's ignition circuit cut-off system has been designed to assist the operator in fulfilling the responsibility of raising the sidestand before starting off. Therefore, check this system regularly and have a Yamaha dealer repair it if it does not function properly.**

EAU63431

## Ignition circuit cut-off system

This system prevents in-gear engine starts unless the clutch lever is pulled and the sidestand is up. Also, it will stop the running engine should the sidestand be lowered while the transmission is in gear.

Periodically check the system via the following procedure.

### TIP

---

- This check is most reliable if performed with a warmed-up engine.
  - See pages 4-2 and 4-22 for switch operation information.
-

# Instrument and control functions

With the engine turned off:

1. Place vehicle on centerstand.
2. Move the sidestand down.
3. Set engine stop switch to run position.
4. Turn main switch to on position.
5. Shift transmission into neutral.
6. Push the start switch.

**Does the engine start?**

YES

NO



**If a malfunction is found, have the vehicle inspected before riding.**

The neutral switch may not be working.  
**The motorcycle should not be ridden** until checked by a Yamaha dealer.

4

With the engine still running:

7. Move the sidestand up.
8. Pull the clutch lever.
9. Shift transmission into gear.
10. Move the sidestand down.

**Does the engine stall?**

YES

NO

The sidestand switch may not be working.  
**The motorcycle should not be ridden** until checked by a Yamaha dealer.

After the engine has stalled:

11. Move the sidestand up.
12. Pull the clutch lever.
13. Push the start switch.

**Does the engine start?**

YES

NO

The clutch switch may not be working.  
**The motorcycle should not be ridden** until checked by a Yamaha dealer.

The system is OK. **The motorcycle can be ridden.**



## Cornering lights

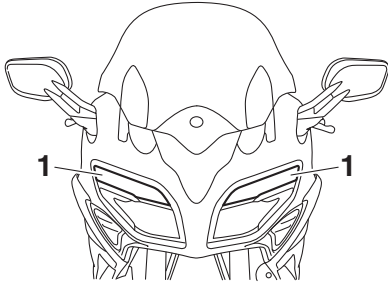

1. Cornering light

This model is equipped with 3 cornering lights on each side. The cornering lights come on to help illuminate the road when the vehicle is leaned over.

According to the direction of the turn, the cornering lights for that side come on. The lights come on in sequence from the inside outward depending on the lean angle of the vehicle.

### **TIP** \_\_\_\_\_

When the vehicle is first powered on, the cornering lights will perform a self-check. Each light should come on in sequence from the inside outward and then return inward.

---

# For your safety – pre-operation checks

EAU63441

Inspect your vehicle each time you use it to make sure the vehicle is in safe operating condition. Always follow the inspection and maintenance procedures and schedules described in the Owner's Manual.

EWA11152

## **WARNING**

**Failure to inspect or maintain the vehicle properly increases the possibility of an accident or equipment damage. Do not operate the vehicle if you find any problem. If a problem cannot be corrected by the procedures provided in this manual, have the vehicle inspected by a Yamaha dealer.**

Before using this vehicle, check the following points:

ITEM	CHECKS	PAGE
<b>Fuel</b>	<ul style="list-style-type: none"><li>• Check fuel level in fuel tank.</li><li>• Refuel if necessary.</li><li>• Check fuel line for leakage.</li><li>• Check fuel tank breather/overflow hose for obstructions, cracks or damage, and check hose connection.</li></ul>	4-29, 4-30
<b>Engine oil</b>	<ul style="list-style-type: none"><li>• Check oil level in engine.</li><li>• If necessary, add recommended oil to specified level.</li><li>• Check vehicle for oil leakage.</li></ul>	7-11
<b>Final gear oil</b>	<ul style="list-style-type: none"><li>• Check vehicle for oil leakage.</li></ul>	7-14
<b>Coolant</b>	<ul style="list-style-type: none"><li>• Check coolant level in reservoir.</li><li>• If necessary, add recommended coolant to specified level.</li><li>• Check cooling system for leakage.</li></ul>	7-16
<b>Front brake</b>	<ul style="list-style-type: none"><li>• Check operation.</li><li>• If soft or spongy, have Yamaha dealer bleed hydraulic system.</li><li>• Check brake pads for wear.</li><li>• Replace if necessary.</li><li>• Check fluid level in reservoir.</li><li>• If necessary, add specified brake fluid to specified level.</li><li>• Check hydraulic system for leakage.</li></ul>	7-25, 7-26
<b>Rear brake</b>	<ul style="list-style-type: none"><li>• Check operation.</li><li>• If soft or spongy, have Yamaha dealer bleed hydraulic system.</li><li>• Check brake pads for wear.</li><li>• Replace if necessary.</li><li>• Check fluid level in reservoir.</li><li>• If necessary, add specified brake fluid to specified level.</li><li>• Check hydraulic system for leakage.</li></ul>	7-25, 7-26

# For your safety – pre-operation checks

ITEM	CHECKS	PAGE
<b>Clutch</b>	<ul style="list-style-type: none"> <li>• Check operation.</li> <li>• If soft or spongy, have Yamaha dealer bleed hydraulic system.</li> <li>• Check fluid level in reservoir.</li> <li>• If necessary, add specified brake fluid to specified level.</li> <li>• Check hydraulic system for leakage.</li> </ul>	7-23, 7-26
<b>Throttle grip</b>	<ul style="list-style-type: none"> <li>• Make sure that operation is smooth.</li> <li>• Check throttle grip free play.</li> <li>• If necessary, have Yamaha dealer adjust throttle grip free play and lubricate cable and grip housing.</li> </ul>	7-19, 7-28
<b>Control cables</b>	<ul style="list-style-type: none"> <li>• Make sure that operation is smooth.</li> <li>• Lubricate if necessary.</li> </ul>	7-28
<b>Wheels and tires</b>	<ul style="list-style-type: none"> <li>• Check for damage.</li> <li>• Check tire condition and tread depth.</li> <li>• Check air pressure.</li> <li>• Correct if necessary.</li> </ul>	7-20, 7-23
<b>Brake and shift pedals</b>	<ul style="list-style-type: none"> <li>• Make sure that operation is smooth.</li> <li>• Lubricate pedal pivoting points if necessary.</li> </ul>	7-29
<b>Brake and clutch levers</b>	<ul style="list-style-type: none"> <li>• Make sure that operation is smooth.</li> <li>• Lubricate lever pivoting points if necessary.</li> </ul>	7-29
<b>Centerstand, side-stand</b>	<ul style="list-style-type: none"> <li>• Make sure that operation is smooth.</li> <li>• Lubricate pivots if necessary.</li> </ul>	7-30
<b>Chassis fasteners</b>	<ul style="list-style-type: none"> <li>• Make sure that all nuts, bolts and screws are properly tightened.</li> <li>• Tighten if necessary.</li> </ul>	—
<b>Instruments, lights, signals and switches</b>	<ul style="list-style-type: none"> <li>• Check operation.</li> <li>• Correct if necessary.</li> </ul>	—
<b>Sidestand switch</b>	<ul style="list-style-type: none"> <li>• Check operation of ignition circuit cut-off system.</li> <li>• If system is not working correctly, have Yamaha dealer check vehicle.</li> </ul>	4-45

# Operation and important riding points

---

EAU15952

EAU73461

Read the Owner's Manual carefully to become familiar with all controls. If there is a control or function you do not understand, ask your Yamaha dealer.

EWA10272

## **WARNING**

---

**Failure to familiarize yourself with the controls can lead to loss of control, which could cause an accident or injury.**

---

## **TIP**

---

This model is equipped with:

- an inertial measurement unit (IMU) that will stop the engine in case of turnover. In this case, turn the main switch off (and then back on) before attempting to restart the engine. Failing to do so will prevent the engine from starting even though the engine will crank when the start switch is pushed.
  - an engine auto-stop system. The engine stops automatically if left idling for 20 minutes. In this case, simply push the start switch to restart the engine.
-

## Starting the engine

In order for the ignition circuit cut-off system to enable starting, one of the following conditions must be met:

- The transmission is in the neutral position.
- The transmission is in gear with the clutch lever pulled and the sidestand up.

See page 4-46 for more information.

1. Turn the key to “ON” and make sure that the start/engine stop switch is set to “○”.

The following warning lights and indicator lights should come on for a few seconds, then go off.

- Oil level warning light
- Engine trouble warning light
- Traction control system indicator light
- Cruise control indicator lights
- Suspension system warning light
- Immobilizer system indicator light

ECA11834

### NOTICE

**If a warning or indicator light does not come on initially when the key is turned to “ON”, or if a warning or indicator light remains on, see page 4-4 for the corresponding warning and indicator light circuit check.**

The ABS warning light should come on when the key is turned to “ON”, and then go off after traveling at a speed of 10 km/h (6 mi/h) or higher.

### NOTICE

**If the ABS warning light does not come on and then go off as explained above, see page 4-4 for the warning light circuit check.**

2. Shift the transmission into the neutral position. The neutral indicator light should come on. If not, ask a Yamaha dealer to check the electrical circuit.
3. Start the engine by pushing the “” side of the start/engine stop switch.

If the engine fails to start, release the start/engine stop switch, wait a few seconds, and then try again. Each starting attempt should be as short as possible to preserve the battery. Do not crank the engine more than 10 seconds on any one attempt.

ECA11043

### NOTICE

**For maximum engine life, never accelerate hard when the engine is cold!**

# Operation and important riding points

## Shifting

EAU16674

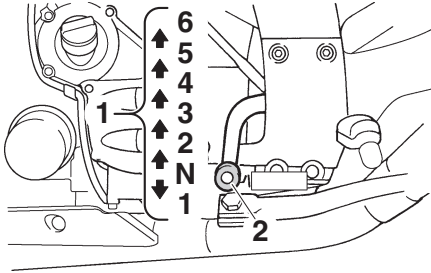

1. Gear positions
2. Shift pedal

Shifting gears lets you control the amount of engine power available for starting off, accelerating, climbing hills, etc.

The gear positions are shown in the illustration.

### TIP

To shift the transmission into the neutral position (N), press the shift pedal down repeatedly until it reaches the end of its travel, and then slightly raise it.

ECA10261

### NOTICE

- **Even with the transmission in the neutral position, do not coast for long periods of time with the engine off, and do not tow the motorcycle for long distances. The transmission is properly lubricated only when the engine is running. Inadequate lubrication may damage the transmission.**
- **Always use the clutch while changing gears to avoid damaging the engine, transmission,**

**and drive train, which are not designed to withstand the shock of forced shifting.**

EAU16682

### To start out and accelerate

1. Pull the clutch lever to disengage the clutch.
2. Shift the transmission into first gear. The neutral indicator light should go out.
3. Open the throttle gradually, and at the same time, release the clutch lever slowly.
4. At the recommended shift points shown in the following table, close the throttle, and at the same time, quickly pull the clutch lever in.
5. Shift the transmission into second gear. (Make sure not to shift the transmission into the neutral position.)
6. Open the throttle part way and gradually release the clutch lever.
7. Follow the same procedure when shifting to the next higher gear.

### TIP

When shifting gears in normal operating conditions, use the recommended shift points.

EAU58270

### To decelerate

1. Release the throttle and apply both the front and the rear brakes smoothly to slow the motorcycle.
2. At the recommended shift points shown in the following table, shift to a lower gear.
3. When the motorcycle reaches 25 km/h (16 mph), the engine is about to stall or runs roughly, pull the

# Operation and important riding points

clutch lever in, use the brakes to slow the motorcycle, and continue to downshift as necessary.

- Once the motorcycle has stopped, the transmission can be shifted into the neutral position. The neutral indicator light should come on and then the clutch lever can be released.

EWA17380

## WARNING

- **Improper braking can cause loss of control or traction. Always use both brakes and apply them smoothly.**
- **Make sure that the motorcycle and the engine have sufficiently slowed before shifting to a lower gear. Engaging a lower gear when the vehicle or engine speed is too high could make the rear wheel lose traction or the engine to over-rev. This could cause loss of control, an accident and injury. It could also cause engine or drive train damage.**

## Recommended shift points

EAU64150

The recommended shift points during acceleration and deceleration are shown in the table below.

### Shift up points:

- 1st → 2nd: 20 km/h (12 mph)
- 2nd → 3rd: 30 km/h (19 mph)
- 3rd → 4th: 40 km/h (25 mph)
- 4th → 5th: 50 km/h (31 mph)
- 5th → 6th: 60 km/h (37 mph)

### Shift down points:

- 6th → 5th: 45 km/h (28 mph)
- 5th → 4th: 35 km/h (22 mph)
- 4th → 3rd: 25 km/h (16 mph)

## Engine break-in

EAU16842

There is never a more important period in the life of your engine than the period between 0 and 1600 km (1000 mi). For this reason, you should read the following material carefully.

Since the engine is brand new, do not put an excessive load on it for the first 1600 km (1000 mi). The various parts in the engine wear and polish themselves to the correct operating clearances. During this period, prolonged full-throttle operation or any condition that might result in engine overheating must be avoided.

EAU17124

### 0–1000 km (0–600 mi)

Avoid prolonged operation above 4500 r/min. **NOTICE:** After 1000 km (600 mi) of operation, the engine oil and final gear oil must be changed, and the oil filter cartridge or element replaced. [ECA10333]

### 1000–1600 km (600–1000 mi)

Avoid prolonged operation above 5400 r/min.

### 1600 km (1000 mi) and beyond

The vehicle can now be operated normally.

ECA10311

## **NOTICE**

- **Keep the engine speed out of the tachometer red zone.**

# Operation and important riding points

---

- If any engine trouble should occur during the engine break-in period, immediately have a Yamaha dealer check the vehicle.
- 

EAU17214

## Parking

When parking, stop the engine, and then remove the key from the main switch.

EWA10312

### **WARNING**

- Since the engine and exhaust system can become very hot, park in a place where pedestrians or children are not likely to touch them and be burned.
  - Do not park on a slope or on soft ground, otherwise the vehicle may overturn, increasing the risk of a fuel leak and fire.
  - Do not park near grass or other flammable materials which might catch fire.
-



# Periodic maintenance and adjustment

---

EAU17246

Periodic inspection, adjustment, and lubrication will keep your vehicle in the safest and most efficient condition possible. Safety is an obligation of the vehicle owner/operator. The most important points of vehicle inspection, adjustment, and lubrication are explained on the following pages.

The intervals given in the periodic maintenance charts should be simply considered as a general guide under normal riding conditions. However, depending on the weather, terrain, geographical location, and individual use, the maintenance intervals may need to be shortened.

EWA10322

## **WARNING**

**Failure to properly maintain the vehicle or performing maintenance activities incorrectly may increase your risk of injury or death during service or while using the vehicle. If you are not familiar with vehicle service, have a Yamaha dealer perform service.**

EWA15123

## **WARNING**

**Turn off the engine when performing maintenance unless otherwise specified.**

- **A running engine has moving parts that can catch on body parts or clothing and electrical parts that can cause shocks or fires.**
- **Running the engine while servicing can lead to eye injury, burns, fire, or carbon monoxide poisoning – possibly leading to**

**death. See page 2-3 for more information about carbon monoxide.**

EWA15461

## **WARNING**

**Brake discs, calipers, drums, and linings can become very hot during use. To avoid possible burns, let brake components cool before touching them.**

# Periodic maintenance and adjustment

EAU17303

EAU85230

Emission controls not only function to ensure cleaner air, but are also vital to proper engine operation and maximum performance. In the following periodic maintenance charts, the services related to emissions control are grouped separately. These services require specialized data, knowledge, and equipment. Maintenance, replacement, or repair of the emission control devices and systems may be performed by any repair establishment or individual that is certified (if applicable). Yamaha dealers are trained and equipped to perform these particular services.

## Tool kit

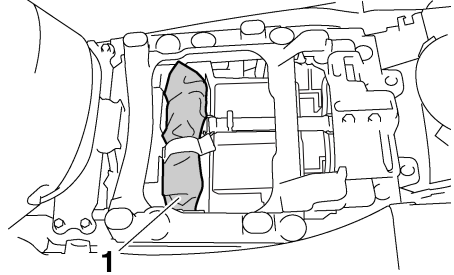

1. Tool kit

The tool kit is in the location shown. The information included in this manual and the tools provided in the tool kit are intended to assist you in the performance of preventive maintenance and minor repairs. However, a torque wrench and other tools are necessary to perform certain maintenance work correctly.

### **TIP**

If you do not have the tools or experience required for a particular job, have your Yamaha dealer perform it for you.

# Periodic maintenance and adjustment

EAU48501

## TIP

- From 37000 km (24000 mi) or 36 months, repeat the maintenance intervals starting from 13000 km (8000 mi) or 12 months.
- Items marked with an asterisk require special tools, data and technical skills, have a Yamaha dealer perform the service.

EAU69111

## Periodic maintenance chart for the emission control system

No.	ITEM	ROUTINE  X 1000 km X 1000 mi month	INITIAL	ODOMETER READINGS					
			1	7	13	19	25	31	
			0.6	4	8	12	16	20	
			1	6	12	18	24	30	
1	* Fuel line	<ul style="list-style-type: none"> <li>• Check fuel hoses for cracks or damage.</li> <li>• Replace if necessary.</li> </ul>		√	√	√	√	√	√
2	* Spark plugs	<ul style="list-style-type: none"> <li>• Check condition.</li> <li>• Adjust gap and clean.</li> </ul>		√		√			√
		<ul style="list-style-type: none"> <li>• Replace.</li> </ul>			√		√		
3	* Valve clearance	<ul style="list-style-type: none"> <li>• Check and adjust valve clearance when engine is cold.</li> </ul>	Every 42000 km (26600 mi)						
4	* Crankcase breather system	<ul style="list-style-type: none"> <li>• Check breather hose for cracks or damage.</li> <li>• Replace if necessary.</li> </ul>		√	√	√	√	√	√
5	* Fuel injection	<ul style="list-style-type: none"> <li>• Adjust synchronization.</li> </ul>	√	√	√	√	√	√	√
6	* Exhaust system	<ul style="list-style-type: none"> <li>• Check for leakage.</li> <li>• Tighten if necessary.</li> <li>• Replace gasket(s) if necessary.</li> </ul>		√	√	√	√	√	√
7	* Air induction system	<ul style="list-style-type: none"> <li>• Check the air cut-off valve, reed valve, and hose for damage.</li> <li>• Replace any damaged parts.</li> </ul>			√		√		

7

# Periodic maintenance and adjustment

EAU69162

## General maintenance and lubrication chart

No.	ITEM	ROUTINE X 1000 km X 1000 mi month	INITIAL	ODOMETER READINGS					
			1	7	13	19	25	31	
			0.6	4	8	12	16	20	
			1	6	12	18	24	30	
1	* Diagnostic system check	<ul style="list-style-type: none"> <li>Perform dynamic inspection using Yamaha diagnostic tool.</li> <li>Check the error codes.</li> </ul>	√	√	√	√	√	√	
2	Air filter element	<ul style="list-style-type: none"> <li>Clean with compressed air.</li> <li>Replace if necessary.</li> </ul>		√	√	√	√	√	
3	* Clutch	<ul style="list-style-type: none"> <li>Check operation, fluid level, and for fluid leakage.</li> <li>Correct if necessary.</li> </ul>	√	√	√	√	√	√	
4	* Front brake	<ul style="list-style-type: none"> <li>Check operation, fluid level, and for fluid leakage.</li> <li>Replace brake pads if necessary.</li> </ul>	√	√	√	√	√	√	
5	* Rear brake	<ul style="list-style-type: none"> <li>Check operation, fluid level, and for fluid leakage.</li> <li>Replace brake pads if necessary.</li> </ul>	√	√	√	√	√	√	
6	* Brake hoses	<ul style="list-style-type: none"> <li>Check for cracks or damage.</li> <li>Check for correct routing and clamping.</li> </ul>		√	√	√	√	√	
		<ul style="list-style-type: none"> <li>Replace.</li> </ul>	Every 4 years						
7	* Brake fluid	<ul style="list-style-type: none"> <li>Change.</li> </ul>	Every 2 years						
8	* Wheels	<ul style="list-style-type: none"> <li>Check runout and for damage.</li> <li>Replace if necessary.</li> </ul>		√	√	√	√	√	
9	* Tires	<ul style="list-style-type: none"> <li>Check tread depth and for damage.</li> <li>Replace if necessary.</li> <li>Check air pressure.</li> <li>Correct if necessary.</li> </ul>		√	√	√	√	√	
10	* Wheel bearings	<ul style="list-style-type: none"> <li>Check bearings for smooth operation.</li> <li>Replace if necessary.</li> </ul>		√	√	√	√	√	
11	* Swingarm pivot bearings	<ul style="list-style-type: none"> <li>Check bearing assemblies for looseness.</li> </ul>			√				
		<ul style="list-style-type: none"> <li>Moderately repack with molybdenum disulfide grease.</li> </ul>					√		
12	* Steering bearings	<ul style="list-style-type: none"> <li>Check bearing assemblies for looseness.</li> </ul>	√	√	√	√	√	√	
		<ul style="list-style-type: none"> <li>Moderately repack with lithium-soap-based grease.</li> </ul>	Every 25000 km (16000 mi)						

# Periodic maintenance and adjustment

No.	ITEM	ROUTINE  X 1000 km X 1000 mi month	INITIAL	ODOMETER READINGS					
			1	7	13	19	25	31	
			0.6	4	8	12	16	20	
			1	6	12	18	24	30	
13	* Chassis fasteners	<ul style="list-style-type: none"> <li>• Check all chassis fitting and fasteners.</li> <li>• Correct if necessary.</li> </ul>		√	√	√	√	√	√
14	Brake lever pivot shaft	<ul style="list-style-type: none"> <li>• Apply silicone grease lightly.</li> </ul>		√	√	√	√	√	√
15	Brake pedal pivot shaft	<ul style="list-style-type: none"> <li>• Apply lithium-soap-based grease lightly.</li> </ul>		√	√	√	√	√	√
16	Clutch lever pivot shaft	<ul style="list-style-type: none"> <li>• Apply silicone grease lightly.</li> </ul>		√	√	√	√	√	√
17	Shift pedal pivot shaft	<ul style="list-style-type: none"> <li>• Apply lithium-soap-based grease lightly.</li> </ul>		√	√	√	√	√	√
18	* Centerstand and sidestand pivots	<ul style="list-style-type: none"> <li>• Check operation.</li> <li>• Apply lithium-soap-based grease lightly.</li> </ul>		√	√	√	√	√	√
19	* Sidestand switch	<ul style="list-style-type: none"> <li>• Check operation and replace if necessary.</li> </ul>	√	√	√	√	√	√	√
20	* Front fork	<ul style="list-style-type: none"> <li>• Check operation and for oil leakage.</li> <li>• Replace if necessary.</li> </ul>		√	√	√	√	√	√
21	* Shock absorber assembly	<ul style="list-style-type: none"> <li>• Check operation and for oil leakage.</li> <li>• Replace if necessary.</li> </ul>		√	√	√	√	√	√
22	* Rear suspension link pivots	<ul style="list-style-type: none"> <li>• Apply molybdenum disulfide grease lightly.</li> </ul>					√		
23	Engine oil	<ul style="list-style-type: none"> <li>• Change (warm engine before draining).</li> </ul>	√	√	√	√	√	√	√
24	Engine oil filter cartridge	<ul style="list-style-type: none"> <li>• Replace.</li> </ul>	√		√		√		
25	* Cooling system	<ul style="list-style-type: none"> <li>• Check hoses for cracks or damage.</li> <li>• Replace if necessary.</li> </ul>		√	√	√	√	√	√
		<ul style="list-style-type: none"> <li>• Change coolant.</li> </ul>					√		
26	* Final gear oil	<ul style="list-style-type: none"> <li>• Check oil level and for leakage.</li> </ul>			√				
		<ul style="list-style-type: none"> <li>• Change.</li> </ul>	√				√		
27	* Front and rear brake switches	<ul style="list-style-type: none"> <li>• Check operation.</li> </ul>	√	√	√	√	√	√	√
28	* Control cables	<ul style="list-style-type: none"> <li>• Apply Yamaha cable lubricant or other suitable cable lubricant thoroughly.</li> </ul>	√	√	√	√	√	√	√

# Periodic maintenance and adjustment

No.	ITEM	ROUTINE X 1000 km X 1000 mi month	INITIAL	ODOMETER READINGS					
			1	7	13	19	25	31	
			0.6	4	8	12	16	20	
			1	6	12	18	24	30	
29	* Throttle grip	<ul style="list-style-type: none"> <li>• Check operation.</li> <li>• Check throttle grip free play, and adjust if necessary.</li> <li>• Lubricate cable and grip housing.</li> <li>• Lubricate grip warmer wire.</li> </ul>		√	√	√	√	√	
30	* Lights, signals and switches	<ul style="list-style-type: none"> <li>• Check operation.</li> <li>• Adjust headlight beam.</li> </ul>	√	√	√	√	√	√	

EAU17661

## TIP

- The air filter needs more frequent service if you are riding in unusually wet or dusty areas.
- Hydraulic brake and clutch systems
  - After disassembling the brake or clutch master cylinders, caliper cylinders or clutch release cylinder, always change the fluid. Regularly check the brake and clutch fluid levels and fill the reservoirs as required.
  - Replace the oil seals on the inner parts of the brake or clutch master cylinders, caliper cylinders and clutch release cylinder every two years.
  - Replace the brake and clutch hoses every four years or if cracked or damaged.

# Periodic maintenance and adjustment

EAU18773

EAU54133

## Removing and installing panels

The panels shown need to be removed to perform some of the maintenance jobs described in this chapter. Refer to this section each time a panel needs to be removed and installed.

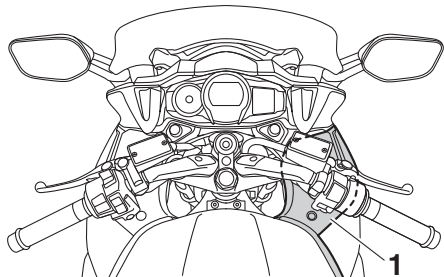

1. Panel A

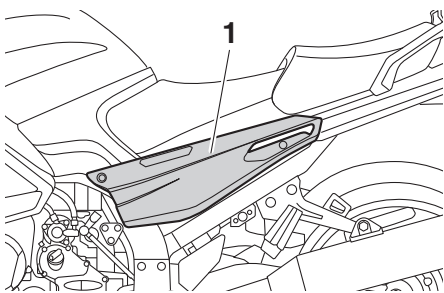

1. Panel B

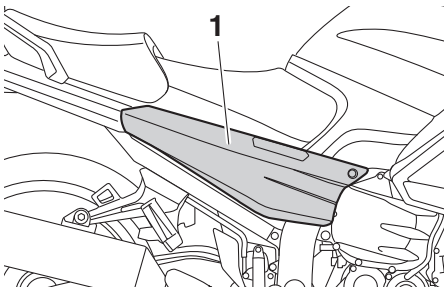

1. Panel C

## Panel A

### To remove the panel

1. Remove the bolts and the quick fasteners.

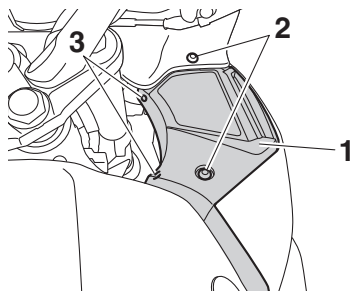

1. Panel A
2. Bolt
3. Quick fastener

2. Release the slot at the rear of the panel from the projection on the right side cowling.

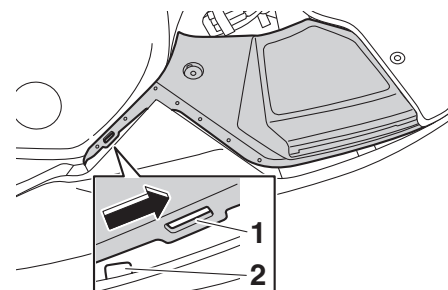

1. Slot
2. Projection

3. Release the slot at the front of the panel from the projection on the front cowling, and then pull the panel off as shown.

# Periodic maintenance and adjustment

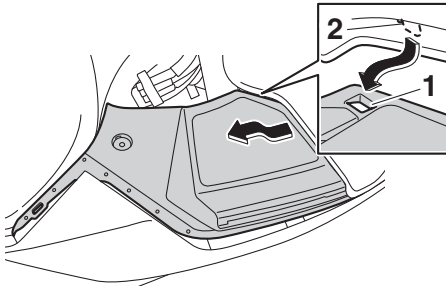

- 1. Slot
- 2. Projection

## To install the panel

1. Fit the slot at the front of the panel under the projection on the front cowling, and then fit the slot at the rear of the panel over the projection on the right side cowling as shown.

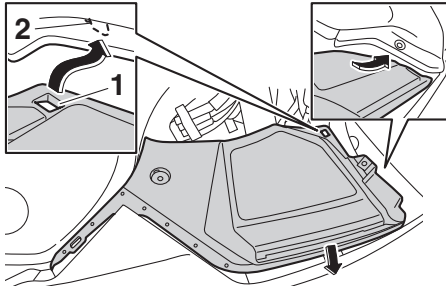

- 1. Slot
- 2. Projection

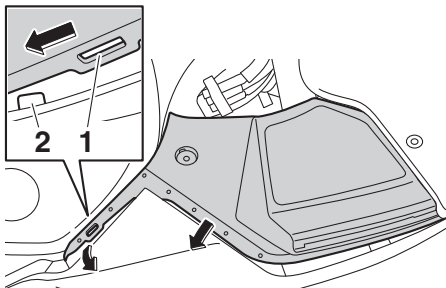

- 1. Slot
- 2. Projection

## TIP

Make sure that the fuses are covered and located to the inside of the panel lip.

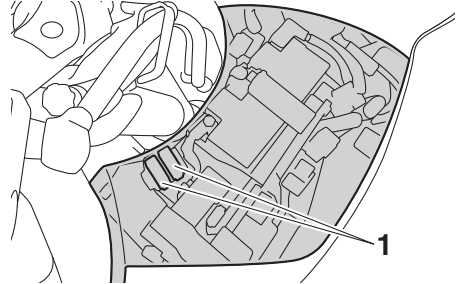

- 1. Fuse

2. Install the bolts and the quick fasteners.

## Panels B and C

### To remove a panel

1. Remove the seats. (See page 4-31.)
2. Remove the bolts and the quick fastener screws.

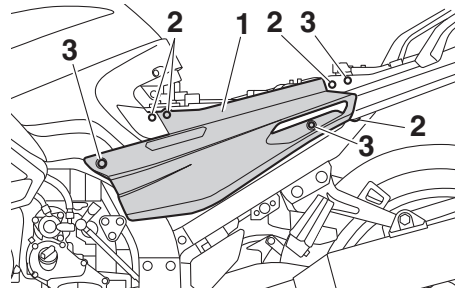

- 1. Panel B
- 2. Quick fastener screw
- 3. Bolt



# Periodic maintenance and adjustment

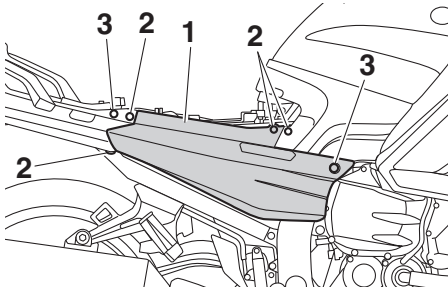

1. Panel C
  2. Quick fastener screw
  3. Bolt
3. Pull the bottom of the panel outward, pull the front of the panel downward, and then slide the panel forward to release it in the rear as shown.

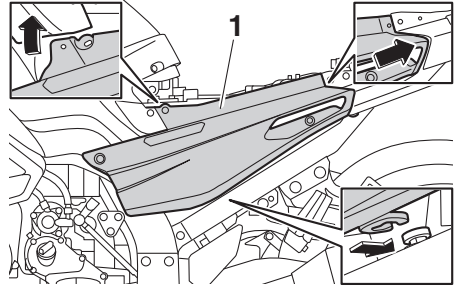

1. Panel B
2. Install the seats.

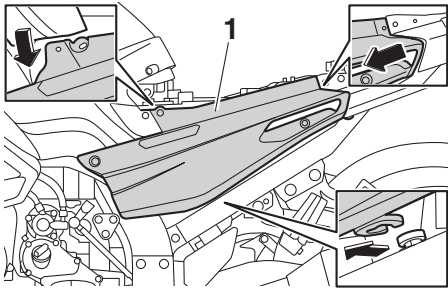

1. Panel B

## To install a panel

1. Place the panel in the original position, and then install the bolts and the quick fastener screws.

# Periodic maintenance and adjustment

EAU19653

## Checking the spark plugs

The spark plugs are important engine components, which should be checked periodically, preferably by a Yamaha dealer. Since heat and deposits will cause any spark plug to slowly erode, they should be removed and checked in accordance with the periodic maintenance and lubrication chart. In addition, the condition of the spark plugs can reveal the condition of the engine.

The porcelain insulator around the center electrode of each spark plug should be a medium-to-light tan (the ideal color when the vehicle is ridden normally), and all spark plugs installed in the engine should have the same color. If any spark plug shows a distinctly different color, the engine could be operating improperly. Do not attempt to diagnose such problems yourself. Instead, have a Yamaha dealer check the vehicle.

If a spark plug shows signs of electrode erosion and excessive carbon or other deposits, it should be replaced.

**Specified spark plug:**  
NGK/CPR8EA-9

Before installing a spark plug, the spark plug gap should be measured with a wire thickness gauge and, if necessary, adjusted to specification.

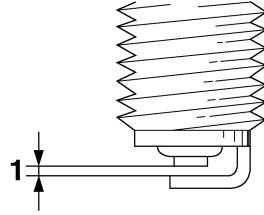

1. Spark plug gap

**Spark plug gap:**  
0.8–0.9 mm (0.031–0.035 in)

Clean the surface of the spark plug gasket and its mating surface, and then wipe off any grime from the spark plug threads.

**Tightening torque:**  
Spark plug:  
13 N·m (1.3 kgf·m, 9.6 lb·ft)

**TIP** \_\_\_\_\_  
If a torque wrench is not available when installing a spark plug, a good estimate of the correct torque is 1/4–1/2 turn past finger tight. However, the spark plug should be tightened to the specified torque as soon as possible.

ECA10841

**NOTICE** \_\_\_\_\_  
**Do not use any tools to remove or install the spark plug cap, otherwise the ignition coil coupler may get damaged. The spark plug cap may be difficult to remove because the rubber seal on the end of the cap fits tightly. To remove the spark plug cap, simply twist it back and forth while pulling it out; to install it, twist it back and forth while pushing it in.**

# Periodic maintenance and adjustment

EAU1988A

## Engine oil and oil filter cartridge

The engine oil level should be checked before each ride. In addition, the oil must be changed and the oil filter cartridge replaced at the intervals specified in the periodic maintenance and lubrication chart.

### To check the engine oil level

1. Place the vehicle on the centerstand. A slight tilt to the side can result in a false reading.
2. Start the engine, warm it up for several minutes, and then turn it off.
3. Wait a few minutes for the oil level to settle for an accurate reading, and then check the oil level through the check window located at the bottom-left side of the crankcase.

### TIP

The engine oil should be between the minimum and maximum level marks.

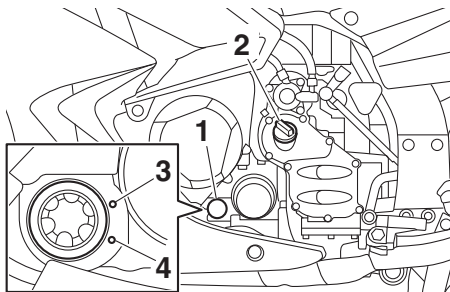

1. Engine oil level check window
2. Engine oil filler cap
3. Maximum level mark
4. Minimum level mark

4. If the engine oil is below the minimum level mark, add sufficient oil of the recommended type to raise it to the correct level.

### TIP

Check the O-ring for damage, and replace it if necessary.

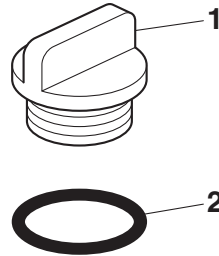

1. Engine oil filler cap
2. O-ring

### To change the engine oil (with or without oil filter cartridge replacement)

1. Place the vehicle on a level surface.
2. Start the engine, warm it up for several minutes, and then turn it off.
3. Place an oil pan under the engine to collect the used oil.
4. Remove the engine oil filler cap, the engine oil drain bolt and its gasket to drain the oil from the crankcase.

# Periodic maintenance and adjustment

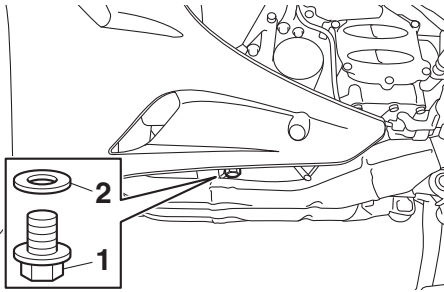

1. Engine oil drain bolt
2. Gasket

**TIP**  
Skip steps 5–7 if the oil filter cartridge is not being replaced.

5. Remove the oil filter cartridge with an oil filter wrench.

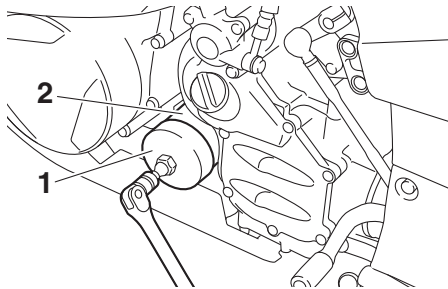

1. Oil filter wrench
2. Oil filter cartridge

**TIP**  
An oil filter wrench is available at a Yamaha dealer.

6. Apply a thin coat of clean engine oil to the O-ring of the new oil filter cartridge.

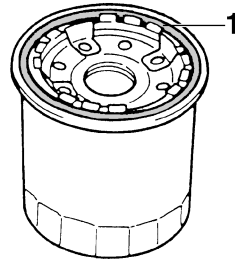

1. O-ring

**TIP**  
Make sure that the O-ring is properly seated.

7. Install the new oil filter cartridge, and then tighten it to the specified torque with a torque wrench.

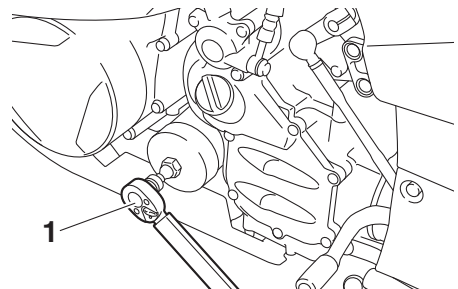

1. Torque wrench

**Tightening torque:**

Oil filter cartridge:  
17 N·m (1.7 kgf·m, 13 lb·ft)

8. Install the engine oil drain bolt and its new gasket, and then tighten the bolt to the specified torque.

**Tightening torque:**

Engine oil drain bolt:  
43 N·m (4.3 kgf·m, 32 lb·ft)

9. Refill with the specified amount of the recommended engine oil.

# Periodic maintenance and adjustment

## Recommended engine oil:

See page 9-1.

## Oil quantity:

Oil change:

3.80 L (4.02 US qt, 3.34 Imp.qt)

With oil filter removal:

4.00 L (4.23 US qt, 3.52 Imp.qt)

## TIP

Be sure to wipe off spilled oil on any parts after the engine and exhaust system have cooled down.

ECA11621

## NOTICE

- In order to prevent clutch slippage (since the engine oil also lubricates the clutch), do not mix any chemical additives. Do not use oils with a diesel specification of “CD” or oils of a higher quality than specified. In addition, do not use oils labeled “ENERGY CONSERVING II” or higher.
- Make sure that no foreign material enters the crankcase.

10. Check the O-ring for damage, and replace it if necessary.

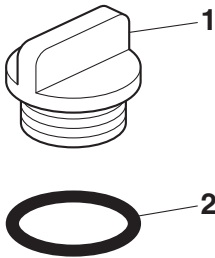

1. Engine oil filler cap
2. O-ring

11. Install and tighten the engine oil filler cap.

12. Start the engine, and then let it idle for several minutes while checking it for oil leakage. If oil is leaking, immediately turn the engine off and check for the cause.

## TIP

After the engine is started, the engine oil level warning light should go off if the oil level is sufficient.

ECA10402

## NOTICE

**If the oil level warning light flickers or remains on even if the oil level is correct, immediately turn the engine off and have a Yamaha dealer check the vehicle.**

13. Turn the engine off, and then check the oil level and correct it if necessary.

# Periodic maintenance and adjustment

---

EAU85450

EAU20017

## Why Yamalube

YAMALUBE oil is a Genuine YAMAHA Part born of the engineers' passion and belief that engine oil is an important liquid engine component. We form teams of specialists in the fields of mechanical engineering, chemistry, electronics and track testing, and have them develop the engine together with the oil it will use. Yamalube oils take full advantage of the base oil's qualities and blend in the ideal balance of additives to make sure the final oil clears our performance standards. Thus, Yamalube mineral, semisynthetic and synthetic oils have their own distinct characters and value. Yamaha's experience gained over many years of research and development into oil since the 1960's helps make Yamalube the best choice for your Yamaha engine.

7



## Final gear oil

The final gear case must be checked for oil leakage before each ride. If any leakage is found, have a Yamaha dealer check and repair the vehicle. In addition, the final gear oil level must be checked and the oil changed as follows at the intervals specified in the periodic maintenance and lubrication chart.

EWA10371

### WARNING

- **Make sure that no foreign material enters the final gear case.**
  - **Make sure that no oil gets on the tire or wheel.**
- 

## To check the final gear oil level

1. Place the vehicle on the center-stand.

### TIP

Make sure that the vehicle is positioned straight up when checking the oil level. A slight tilt to the side can result in a false reading.

---

2. Remove the final gear oil filler bolt and its gasket, and then check the oil level in the final gear case.

### TIP

The oil level should be at the brim of the filler hole.

---

# Periodic maintenance and adjustment

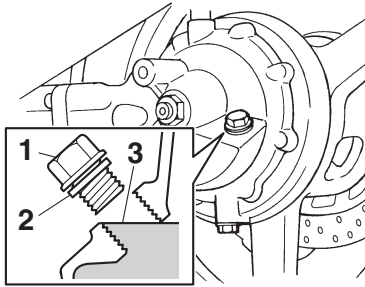

1. Final gear oil filler bolt
  2. Gasket
  3. Correct oil level
3. If the oil is below the brim of the filler hole, add sufficient oil of the recommended type to raise it to the correct level.
  4. Check the gasket for damage, and replace it if necessary.
  5. Install the final gear oil filler bolt and its gasket, and then tighten the bolt to the specified torque.

### Tightening torque:

Final gear oil filler bolt:  
23 N·m (2.3 kgf·m, 17 lb·ft)

### To change the final gear oil

1. Place the vehicle on a level surface.
2. Place an oil pan under the final gear case to collect the used oil.
3. Remove the final gear oil filler bolt, the final gear oil drain bolt and their gasket to drain the oil from the final gear case.

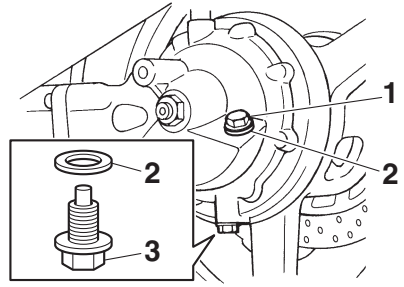

1. Final gear oil filler bolt
  2. Gasket
  3. Final gear oil drain bolt
4. Install the final gear oil drain bolt and its new gasket, and then tighten the bolt to the specified torque.

### Tightening torque:

Final gear oil drain bolt:  
23 N·m (2.3 kgf·m, 17 lb·ft)

5. Refill with the recommended final gear oil to the brim of the filler hole.

### Recommended final gear oil:

Yamaha genuine shaft drive gear oil  
SAE 80W-90 API GL-5

### Oil quantity:

0.20 L (0.21 US qt, 0.18 Imp.qt)

6. Check the oil filler bolt gasket for damage, and replace it if necessary.
7. Install the oil filler bolt and its gasket, and then tighten the bolt to the specified torque.

### Tightening torque:

Final gear oil filler bolt:  
23 N·m (2.3 kgf·m, 17 lb·ft)

8. Check the final gear case for oil leakage. If oil is leaking, check for the cause.

# Periodic maintenance and adjustment

EAUS1203

## Coolant

The coolant level should be checked regularly. In addition, the coolant must be changed at the intervals specified in the periodic maintenance chart.

### Recommended coolant:

YAMALUBE coolant

### Coolant quantity:

Coolant reservoir (max level mark):

0.25 L (0.26 US qt, 0.22 Imp.qt)

Radiator (including all routes):

2.60 L (2.75 US qt, 2.29 Imp.qt)

## TIP

If genuine Yamaha coolant is not available, use an ethylene glycol antifreeze containing corrosion inhibitors for aluminum engines and mix with distilled water at a 1:1 ratio.

EAU54164

## To check the coolant level

1. Wait for the engine to cool. The coolant level will vary with engine temperature.
2. Place the vehicle on the center-stand.
3. Remove the left cowling vent panel. (See page 4-38.)
4. Look at the coolant reservoir.

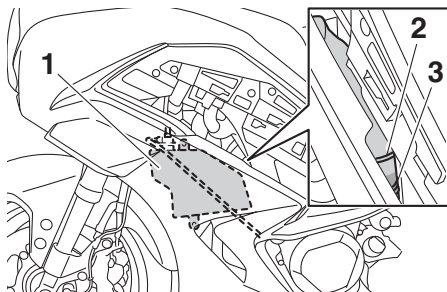

1. Coolant reservoir
2. Maximum level mark
3. Minimum level mark

5. If the coolant is at or below the minimum level mark, remove the coolant reservoir cap. **WARNING! Remove only the coolant reservoir cap. Never attempt to remove the radiator cap when the engine is hot.** [EWA15162]

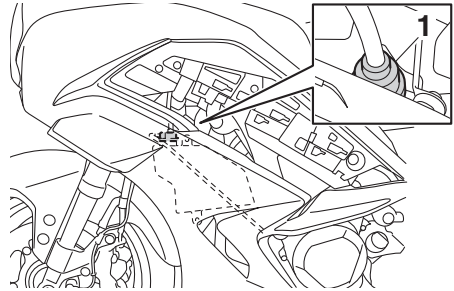

1. Coolant reservoir cap

6. Add coolant or distilled water to raise the coolant to the maximum level mark, and install the coolant reservoir cap. **NOTICE: If coolant is not available, use distilled water or soft tap water instead. Do not use hard water or salt water since it is harmful to the engine. If water has been used instead of coolant, replace it with coolant as soon as possible, otherwise the cooling system will not be protected against frost and corrosion. If water has been added to the coolant, have a Yamaha dealer check the anti-freeze content of the coolant as soon as possible, otherwise the effectiveness of the coolant will be reduced.** [ECA10473]
7. Install the panel.



# Periodic maintenance and adjustment

EAU33032

EAU20474

## Changing the coolant

The coolant must be changed at the intervals specified in the periodic maintenance and lubrication chart. Have a Yamaha dealer change the coolant.

**WARNING! Never attempt to remove the radiator cap when the engine is hot.** [EWA10382]

## Cleaning the air filter element

The air filter element should be cleaned or replaced at the intervals specified in the periodic maintenance and lubrication chart. Clean or, if necessary, replace the air filter element more frequently if you are riding in unusually wet or dusty areas.

1. Remove panel B. (See page 7-7.)
2. Remove the intake air shroud by removing the screw and the quick fastener screws.

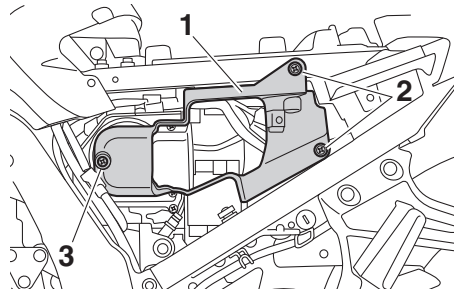

1. Intake air shroud
2. Quick fastener screw
3. Screw

3. Remove the air filter case cover by removing the screws.

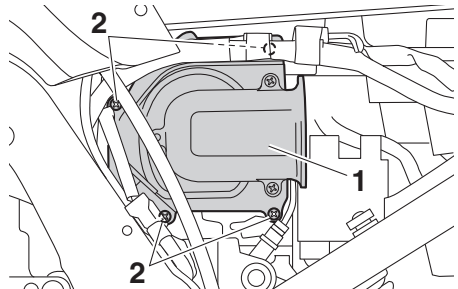

1. Air filter case cover
2. Screw

4. Pull the air filter element out.

# Periodic maintenance and adjustment

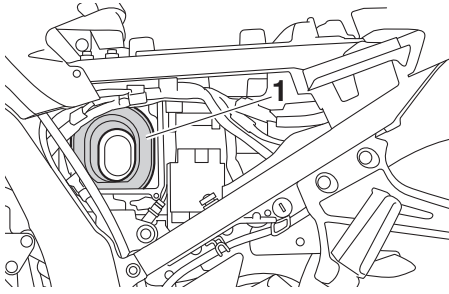

1. Air filter element

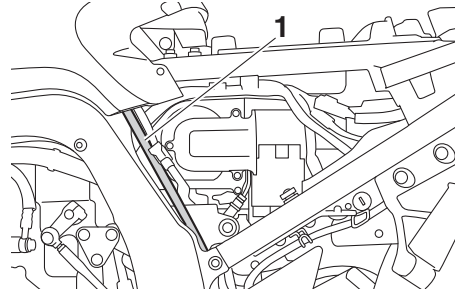

1. Fuel tank breather/overflow hose

- Lightly tap the air filter element to remove most of the dust and dirt, and then blow the remaining dirt out with compressed air as shown. If the air filter element is damaged, replace it.

- Install the intake air shroud by installing the screw and the quick fastener screws.
- Install the panel.

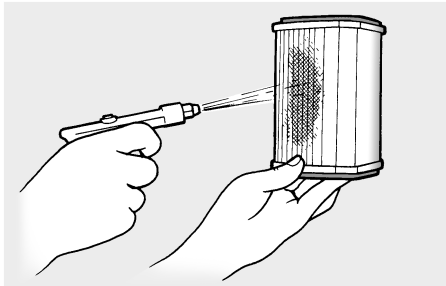

- Insert the air filter element into the air filter case. **NOTICE:** Make sure that the air filter element is properly seated in the air filter case. The engine should never be operated without the air filter element installed, otherwise the piston(s) and/or cylinder(s) may become excessively worn.

[ECA10482]

- Install the air filter case cover by installing the screws. **NOTICE:** Make sure that the fuel tank breather/overflow hose is not pinched. [ECA15412]

# Periodic maintenance and adjustment

EAU44735

EAU21386

## Checking the engine idling speed

Check the engine idling speed and, if necessary, have it corrected by a Yamaha dealer.

**Engine idling speed:**  
1000–1100 r/min

## Checking the throttle grip free play

Measure the throttle grip free play as shown.

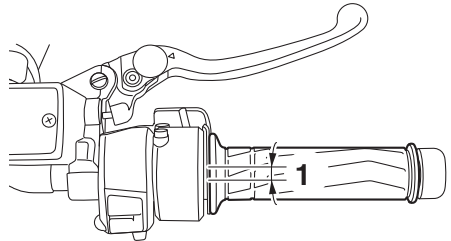

1. Throttle grip free play

**Throttle grip free play:**  
1.0–3.0 mm (0.04–0.12 in)

Periodically check the throttle grip free play and, if necessary, have a Yamaha dealer adjust it.

# Periodic maintenance and adjustment

---

EAU21403

EAU64261

## Valve clearance

The valves are an important engine component, and since valve clearance changes with use, they must be checked and adjusted at the intervals specified in the periodic maintenance chart. Unadjusted valves can result in improper air-fuel mixture, engine noise, and eventually engine damage. To prevent this from occurring, have your Yamaha dealer check and adjust the valve clearance at regular intervals.

### TIP

---

This service must be performed when the engine is cold.

---

## Tires

Tires are the only contact between the vehicle and the road. Safety in all conditions of riding depends on a relatively small area of road contact. Therefore, it is essential to maintain the tires in good condition at all times and replace them at the appropriate time with the specified tires.

### Tire air pressure

The tire air pressure should be checked and, if necessary, adjusted before each ride.

EWA10504



---

Operation of this vehicle with improper tire pressure may cause severe injury or death from loss of control.

- The tire air pressure must be checked and adjusted on cold tires (i.e., when the temperature of the tires equals the ambient temperature).
  - The tire air pressure must be adjusted in accordance with the riding speed and with the total weight of rider, passenger, cargo, and accessories approved for this model.
-

# Periodic maintenance and adjustment

## Cold tire air pressure:

### Up to 90 kg (198 lb) load:

Front:  
250 kPa (2.50 kgf/cm<sup>2</sup>, 36 psi)

Rear:  
290 kPa (2.90 kgf/cm<sup>2</sup>, 42 psi)

### 90 kg (198 lb) to maximum load:

Front:  
250 kPa (2.50 kgf/cm<sup>2</sup>, 36 psi)

Rear:  
290 kPa (2.90 kgf/cm<sup>2</sup>, 42 psi)

### Maximum load:

Vehicle:  
213 kg (470 lb)

The vehicle's maximum load is the combined weight of the rider, passenger, cargo, and any accessories.

**Minimum tire tread depth (front and rear):**

1.0 mm (0.04 in)

## TIP

The tire tread depth limit may differ from province to province. Always comply with the local regulations.

EWA10472

## WARNING

- Have a Yamaha dealer replace excessively worn tires. Besides being illegal, operating the vehicle with excessively worn tires decreases riding stability and can lead to loss of control.
- The replacement of all wheel and brake-related parts, including the tires, should be left to a Yamaha dealer, who has the necessary professional knowledge and experience to do so.
- Ride at moderate speeds after changing a tire since the tire surface must first be "broken in" for it to develop its optimal characteristics.

7

## WARNING

Never overload your vehicle. Operation of an overloaded vehicle could cause an accident.

EWA10512

## Tire inspection

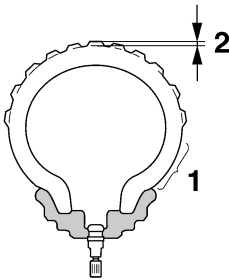

1. Tire sidewall
2. Tire tread depth

The tires must be checked before each ride. If the center tread depth reaches the specified limit, if the tire has a nail or glass fragments in it, or if the sidewall is cracked, have a Yamaha dealer replace the tire immediately.

## Tire information

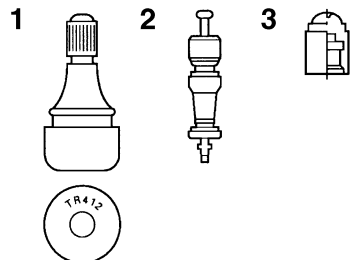

1. Tire air valve
2. Tire air valve core
3. Tire air valve cap with seal

# Periodic maintenance and adjustment

EWA10601

This model is equipped with tubeless tires and tire air valves.

Tires age, even if they have not been used or have only been used occasionally. Cracking of the tread and sidewall rubber, sometimes accompanied by carcass deformation, is an evidence of ageing. Old and aged tires shall be checked by tire specialists to ascertain their suitability for further use.

EWA10902

## WARNING

- **The front and rear tires should be of the same make and design, otherwise the handling characteristics of the motorcycle may be different, which could lead to an accident.**
- **Always make sure that the valve caps are securely installed to prevent air pressure leakage.**
- **Use only the tire valves and valve cores listed below to avoid tire deflation during a ride.**

After extensive tests, only the tires listed below have been approved for this model by Yamaha.

### **Front tire:**

Size:

120/70ZR17M/C (58W)

Manufacturer/model:

BRIDGESTONE/BT023F E

### **Rear tire:**

Size:

180/55ZR17M/C(73W)

Manufacturer/model:

BRIDGESTONE/BT023R E

### **FRONT and REAR:**

Tire air valve:

TR412

Valve core:

#9100 (original)

## WARNING

**This motorcycle is fitted with super-high-speed tires. Note the following points in order to make the most efficient use of these tires.**

- **Use only the specified replacement tires. Other tires may run the danger of bursting at super high speeds.**
- **Brand-new tires can have a relatively poor grip on certain road surfaces until they have been “broken in”. Therefore, it is advisable before doing any high-speed riding to ride conservatively for approximately 100 km (60 mi) after installing a new tire.**
- **The tires must be warmed up before a high-speed run.**
- **Always adjust the tire air pressure according to the operating conditions.**

## Cast wheels

To maximize the performance, durability, and safe operation of your vehicle, note the following points regarding the specified wheels.

- The wheel rims should be checked for cracks, bends, warpage or other damage before each ride. If any damage is found, have a Yamaha dealer replace the wheel. Do not attempt even the smallest repair to the wheel. A deformed or cracked wheel must be replaced.
- The wheel should be balanced whenever either the tire or wheel has been changed or replaced. An unbalanced wheel can result in poor performance, adverse handling characteristics, and a shortened tire life.

## Clutch lever

Since this model is equipped with a hydraulic clutch, adjusting the clutch lever free play is not needed. However, it is necessary to check the clutch fluid level and check the hydraulic system for leakage. (See page 7-26.)

### **TIP**

---

If clutch lever free play becomes excessive, shifting becomes rough, or clutch slippage occurs, there may be air in the clutch system. Have a Yamaha dealer bleed or replace the hydraulic clutch fluid.

---

# Periodic maintenance and adjustment

## Checking the brake lever free play

EAU37914

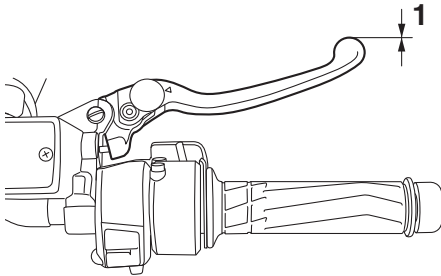

1. No brake lever free play

There should be no free play at the brake lever end. If there is free play, have a Yamaha dealer inspect the brake system.

EWA14212

### **WARNING**

**A soft or spongy feeling in the brake lever can indicate the presence of air in the hydraulic system. If there is air in the hydraulic system, have a Yamaha dealer bleed the system before operating the vehicle. Air in the hydraulic system will diminish the braking performance, which may result in loss of control and an accident.**

## Brake light switches

EAU36505

The brake light should come on just before braking takes effect. The brake light is activated by switches connected to the brake lever and brake pedal. Since the brake light switches are components of the anti-lock brake system, they should only be serviced by a Yamaha dealer.



# Periodic maintenance and adjustment

## Checking the front and rear brake pads

EAU22393

The front and rear brake pads must be checked for wear at the intervals specified in the periodic maintenance and lubrication chart.

### Front brake pads

EAU43432

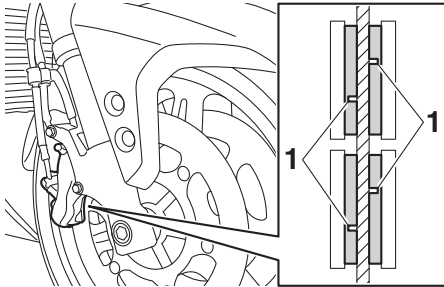

1. Brake pad wear indicator groove

The front brake calipers are equipped with two sets of brake pads.

Each front brake pad is provided with a wear indicator groove, which allows you to check the brake pad wear without having to disassemble the brake. To check a brake pad for wear, check its wear indicator groove. If a brake pad has worn to the point that the wear indicator groove has almost disappeared, have a Yamaha dealer replace the brake pads as a set.

### Rear brake pads

EAU22501

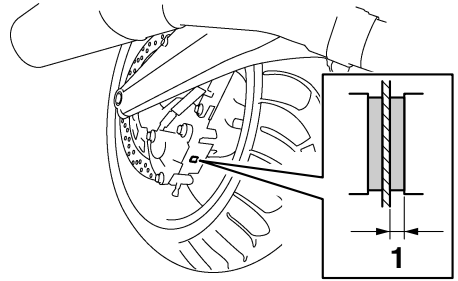

1. Lining thickness

Check each rear brake pad for damage and measure the lining thickness. If a brake pad is damaged or if the lining thickness is less than 0.8 mm (0.03 in), have a Yamaha dealer replace the brake pads as a set.

# Periodic maintenance and adjustment

EAU40272

## Checking the brake and clutch fluid levels

Before riding, check that the brake and clutch fluids are above the minimum level marks. Check the brake and clutch fluid levels with the tops of the reservoirs level. Replenish the brake and clutch fluids if necessary.

### Front brake

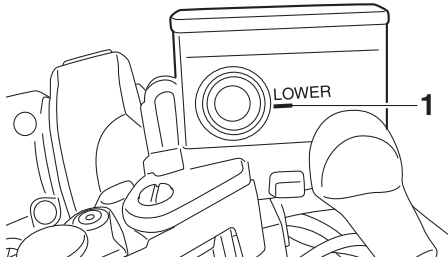

1. Minimum level mark

### Clutch

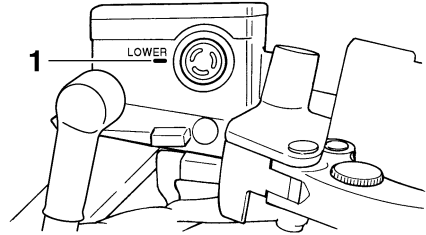

1. Minimum level mark

### TIP

The rear brake fluid reservoir is located behind panel C. (See page 7-7.)

**Specified brake and clutch fluid:**  
DOT 4 brake fluid

EWA16031

### **WARNING**

Improper maintenance can result in loss of braking ability or clutch operation. Observe these precautions:

- Insufficient brake or clutch fluid may allow air to enter the brake or clutch system, reducing braking or clutch performance.
- Clean the filler caps before removing. Use only DOT 4 brake fluid from a sealed container.
- Use only the specified brake fluid; otherwise, the rubber seals may deteriorate, causing leakage.
- Refill with the same type of brake fluid. Adding a brake fluid other than DOT 4 may result in a harmful chemical reaction.
- Be careful that water or dust does not enter the brake or clutch fluid reservoir when refilling. Water will significantly low-

7

### Rear brake

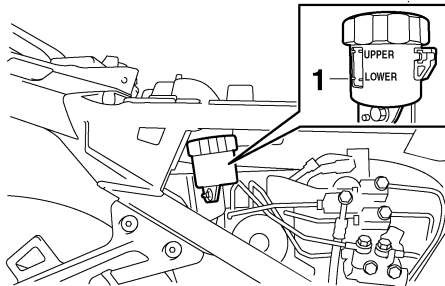

1. Minimum level mark

# Periodic maintenance and adjustment

er the boiling point of the fluid and may result in vapor lock, and dirt may clog the ABS hydraulic unit valves.

EAU22754

## Changing the brake and clutch fluids

Have a Yamaha dealer change the brake and clutch fluids at the intervals specified in the periodic maintenance and lubrication chart. In addition, have the oil seals of the brake and clutch master cylinders and calipers as well as the brake and clutch hoses replaced at the intervals listed below or whenever they are damaged or leaking.

- Oil seals: Replace every two years.
- Brake and clutch hoses: Replace every four years.

### NOTICE

ECA17641

**Brake fluid may damage painted surfaces or plastic parts. Always clean up spilled fluid immediately.**

The brake or clutch fluid reservoir diaphragm will lose its shape from the negative pressure if the fluid level goes down too far. Be sure to return the diaphragm to its original shape before installing it into the brake or clutch fluid reservoir.

As the brake pads wear, it is normal for the brake fluid level to gradually go down. A low brake fluid level may indicate worn brake pads and/or brake system leakage; therefore, be sure to check the brake pads for wear and the brake system for leakage. A low clutch fluid level may indicate clutch system leakage; therefore, be sure to check the clutch system for leakage. If the brake or clutch fluid level goes down suddenly, have a Yamaha dealer check the cause before further riding.

# Periodic maintenance and adjustment

---

EAU23098

## Checking and lubricating the cables

The operation of all control cables and the condition of the cables should be checked before each ride, and the cables and cable ends should be lubricated if necessary. If a cable is damaged or does not move smoothly, have a Yamaha dealer check or replace it. **WARNING! Damage to the outer housing of cables may result in internal rusting and cause interference with cable movement. Replace damaged cables as soon as possible to prevent unsafe conditions.** [EWA10712]

**Recommended lubricant:**

Yamaha cable lubricant or other suitable cable lubricant

EAU23115

## Checking and lubricating the throttle grip and cable

The operation of the throttle grip should be checked before each ride. In addition, the cable should be lubricated by a Yamaha dealer at the intervals specified in the periodic maintenance chart.

The throttle cable is equipped with a rubber cover. Make sure that the cover is securely installed. Even though the cover is installed correctly, it does not completely protect the cable from water entry. Therefore, use care not to pour water directly onto the cover or cable when washing the vehicle. If the cable or cover becomes dirty, wipe clean with a moist cloth.

# Periodic maintenance and adjustment

EAU44276

## Checking and lubricating the brake and shift pedals

The operation of the brake and shift pedals should be checked before each ride, and the pedal pivots should be lubricated if necessary.

### Brake pedal

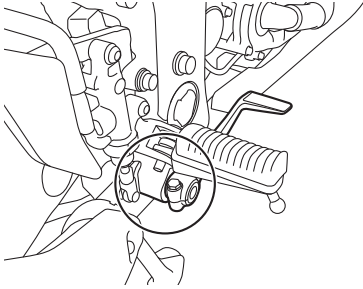

### Shift pedal

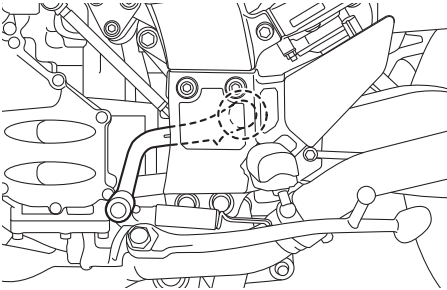

**Recommended lubricant:**  
Lithium-soap-based grease

EAU43602

## Checking and lubricating the brake and clutch levers

The operation of the brake and clutch levers should be checked before each ride, and the lever pivots should be lubricated if necessary.

### Brake lever

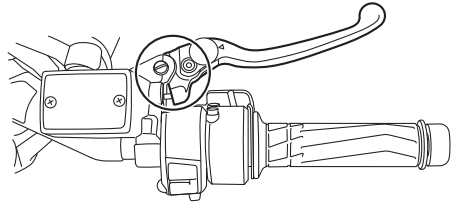

### Clutch lever

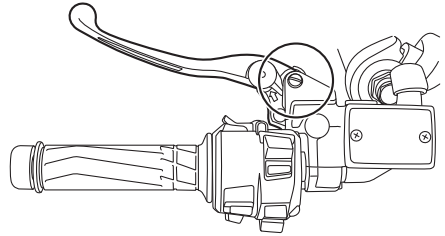

**Recommended lubricant:**  
Silicone grease

# Periodic maintenance and adjustment

## Checking and lubricating the centerstand and sidestand

EAU23215

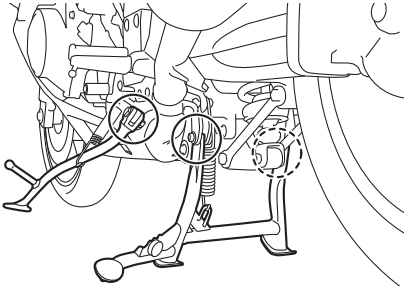

The operation of the centerstand and sidestand should be checked before each ride, and the pivots and metal-to-metal contact surfaces should be lubricated if necessary.

EWA10742

### **WARNING**

If the centerstand or sidestand does not move up and down smoothly, have a Yamaha dealer check or repair it. Otherwise, the centerstand or sidestand could contact the ground and distract the operator, resulting in a possible loss of control.

**Recommended lubricant:**  
Lithium-soap-based grease

## Lubricating the rear suspension

EAU85250

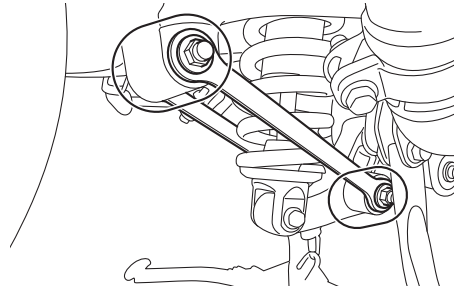

The pivoting points of the rear suspension must be lubricated by a Yamaha dealer at the intervals specified in the periodic maintenance and lubrication chart.

**Recommended lubricant:**  
Molybdenum disulfide grease

# Periodic maintenance and adjustment

EAUM2703

## Lubricating the swingarm pivots

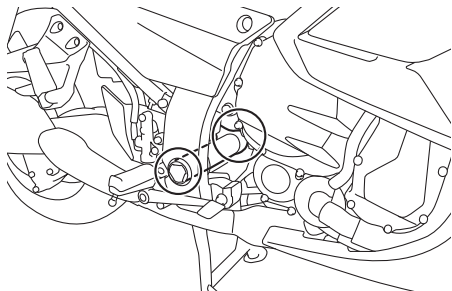

The swingarm pivots must be lubricated by a Yamaha dealer at the intervals specified in the periodic maintenance and lubrication chart.

### Recommended lubricant:

Molybdenum disulfide grease

EAU23273

## Checking the front fork

The condition and operation of the front fork must be checked as follows at the intervals specified in the periodic maintenance and lubrication chart.

### To check the condition

Check the inner tubes for scratches, damage and excessive oil leakage.

### To check the operation

1. Place the vehicle on a level surface and hold it in an upright position. **WARNING! To avoid injury, securely support the vehicle so there is no danger of it falling over.** [EWA10752]
2. While applying the front brake, push down hard on the handlebars several times to check if the front fork compresses and rebounds smoothly.

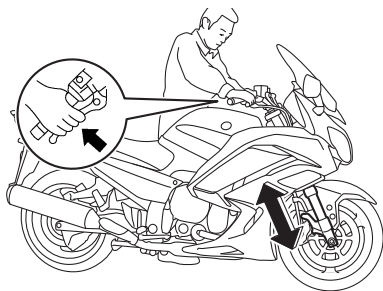

ECA10591

### NOTICE

**If any damage is found or the front fork does not operate smoothly, have a Yamaha dealer check or repair it.**

# Periodic maintenance and adjustment

EAU45512

## Checking the steering

Worn or loose steering bearings may cause danger. Therefore, the operation of the steering must be checked as follows at the intervals specified in the periodic maintenance and lubrication chart.

1. Place the vehicle on the centerstand. **WARNING! To avoid injury, securely support the vehicle so there is no danger of it falling over.** [EWA10752]
2. Hold the lower ends of the front fork legs and try to move them forward and backward. If any free play can be felt, have a Yamaha dealer check or repair the steering.

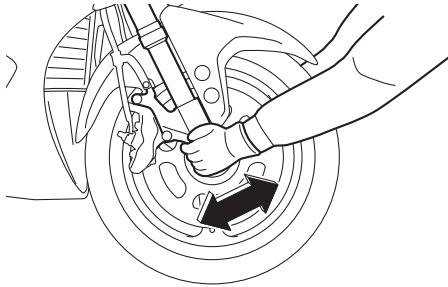

EAU23292

## Checking the wheel bearings

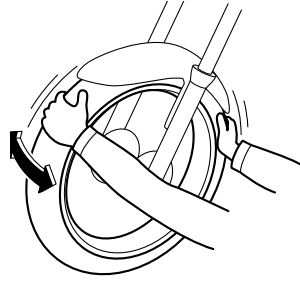

The front and rear wheel bearings must be checked at the intervals specified in the periodic maintenance and lubrication chart. If there is play in the wheel hub or if the wheel does not turn smoothly, have a Yamaha dealer check the wheel bearings.



# Periodic maintenance and adjustment

## Battery

EAU39527

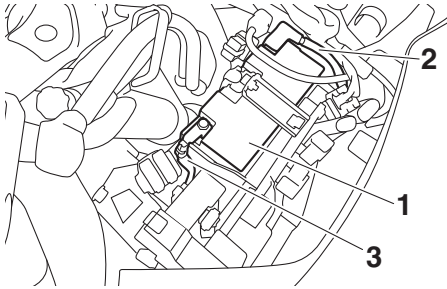

1. Battery
2. Positive battery lead (red)
3. Negative battery lead (black)

The battery is located under panel A. (See page 7-7.)

This model is equipped with a VRLA (Valve Regulated Lead Acid) battery. There is no need to check the electrolyte or to add distilled water. However, the battery lead connections need to be checked and, if necessary, tightened.

EWA10761

### **! WARNING**

- **Electrolyte is poisonous and dangerous since it contains sulfuric acid, which causes severe burns. Avoid any contact with skin, eyes or clothing and always shield your eyes when working near batteries. In case of contact, administer the following FIRST AID.**
  - **EXTERNAL:** Flush with plenty of water.
  - **INTERNAL:** Drink large quantities of water or milk and immediately call a physician.
  - **EYES:** Flush with water for 15 minutes and seek prompt medical attention.

- **Batteries produce explosive hydrogen gas. Therefore, keep sparks, flames, cigarettes, etc., away from the battery and provide sufficient ventilation when charging it in an enclosed space.**
- **KEEP THIS AND ALL BATTERIES OUT OF THE REACH OF CHILDREN.**

### To charge the battery

Have a Yamaha dealer charge the battery as soon as possible if it seems to have discharged. Keep in mind that the battery tends to discharge more quickly if the vehicle is equipped with optional electrical accessories.

ECA16522

### **NOTICE**

**To charge a VRLA (Valve Regulated Lead Acid) battery, a special (constant-voltage) battery charger is required. Using a conventional battery charger will damage the battery.**

### To store the battery

1. If the vehicle will not be used for more than one month, remove the battery, fully charge it, and then place it in a cool, dry place. **NOTICE:** When removing the battery, be sure to turn the main switch off, then disconnect the negative lead before disconnecting the positive lead. [ECA16304]
2. If the battery will be stored for more than two months, check it at least once a month and fully charge it if necessary.

# Periodic maintenance and adjustment

EAU54515

3. Fully charge the battery before installation. **NOTICE: When installing the battery, be sure to turn the main switch off, then connect the positive lead before connecting the negative lead.**

[ECA16842]

4. After installation, make sure that the battery leads are properly connected to the battery terminals.

ECA16531

## **NOTICE**

**Always keep the battery charged. Storing a discharged battery can cause permanent battery damage.**

## Replacing the fuses

The fuse boxes and individual fuses are located under panel A. (See page 7-7.)

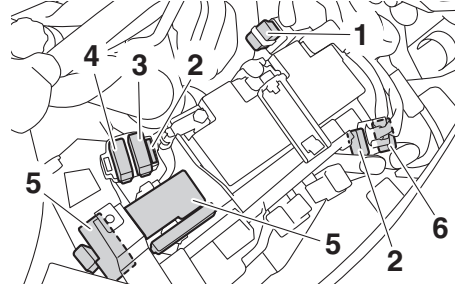

1. Main fuse
2. Spare fuse
3. Cruise control fuse
4. Brake light fuse
5. Fuse box
6. Main fuse 2

# Periodic maintenance and adjustment

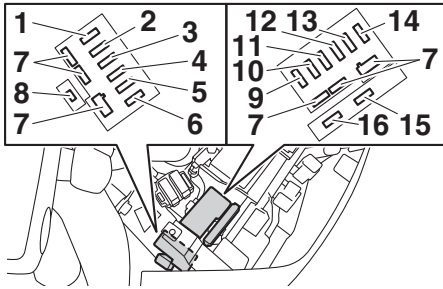

1. ABS motor fuse
2. ABS solenoid fuse
3. Fuel injection system fuse
4. Backup fuse (for clock and immobilizer system)
5. Electronic throttle valve fuse
6. Headlight fuse
7. Spare fuse
8. Suspension fuse
9. Signaling system fuse
10. Terminal fuse 1 (for auxiliary DC jack)
11. ABS control unit fuse
12. Ignition fuse
13. Right radiator fan motor fuse
14. Left radiator fan motor fuse
15. Hazard fuse
16. Windshield motor fuse

If a fuse is blown, replace it as follows.

1. Turn the key to “OFF” and turn off the electrical circuit in question.
2. Remove the blown fuse, and then install a new fuse of the specified amperage. **WARNING! Do not use a fuse of a higher amperage rating than recommended to avoid causing extensive damage to the electrical system and possibly a fire.** [EWA15132]

## Specified fuses:

- Main fuse:  
50.0 A
- Main fuse 2:  
30.0 A
- Terminal fuse 1:  
3.0 A
- Headlight fuse:  
7.5 A
- Brake light fuse:  
1.0 A
- Signaling system fuse:  
7.5 A
- Ignition fuse:  
20.0 A
- Radiator fan motor fuse:  
10.0 A × 2
- Backup fuse:  
7.5 A
- Hazard fuse:  
7.5 A
- Fuel injection system fuse:  
15.0 A
- ABS control unit fuse:  
7.5 A
- ABS motor fuse:  
30.0 A
- ABS solenoid fuse:  
20.0 A
- Suspension fuse:  
15.0 A
- Cruise control fuse:  
1.0 A
- Windshield motor fuse:  
20.0 A
- Electronic throttle valve fuse:  
7.5 A

3. Turn the key to “ON” and turn on the electrical circuit in question to check if the device operates.
4. If the fuse immediately blows again, have a Yamaha dealer check the electrical system.

# Periodic maintenance and adjustment

EAU72980

EAU25872

## Vehicle lights

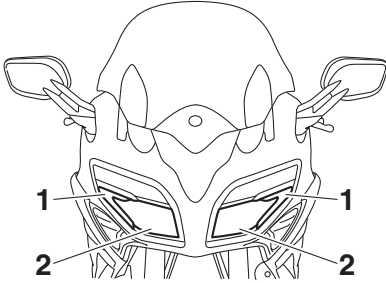

1. Auxiliary light
2. Headlight

This model is equipped with full-LED lighting. There are no user replaceable bulbs.

If a light does not come on, check the fuses and then have a Yamaha dealer check the vehicle.

ECA16581

### **NOTICE**

**Do not affix any type of tinted film or stickers to the headlight lens.**

## Troubleshooting

Although Yamaha motorcycles receive a thorough inspection before shipment from the factory, trouble may occur during operation. Any problem in the fuel, compression, or ignition systems, for example, can cause poor starting and loss of power.

The following troubleshooting charts represent quick and easy procedures for checking these vital systems yourself. However, should your motorcycle require any repair, take it to a Yamaha dealer, whose skilled technicians have the necessary tools, experience, and know-how to service the motorcycle properly.

Use only genuine Yamaha replacement parts. Imitation parts may look like Yamaha parts, but they are often inferior, have a shorter service life and can lead to expensive repair bills.

EWA15142

### **WARNING**

**When checking the fuel system, do not smoke, and make sure there are no open flames or sparks in the area, including pilot lights from water heaters or furnaces. Gasoline or gasoline vapors can ignite or explode, causing severe injury or property damage.**

# Periodic maintenance and adjustment

EAU63470

## Troubleshooting charts

### Starting problems or poor engine performance

#### 1. Fuel

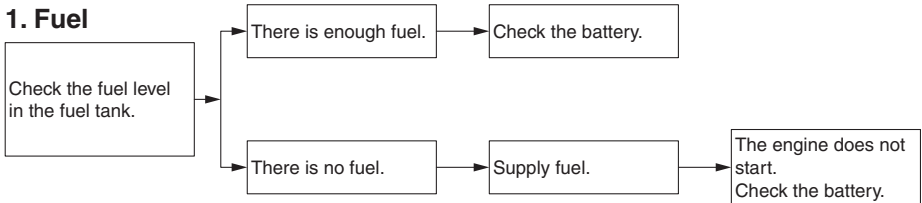

#### 2. Battery

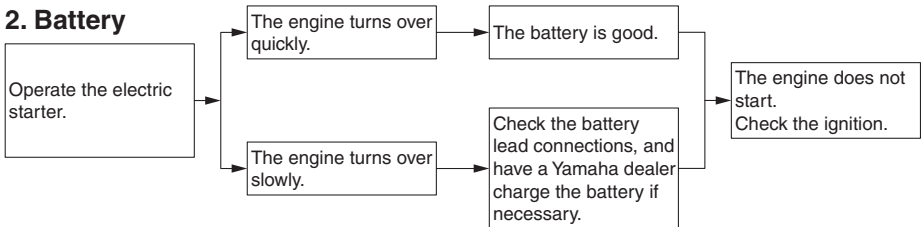

#### 3. Ignition

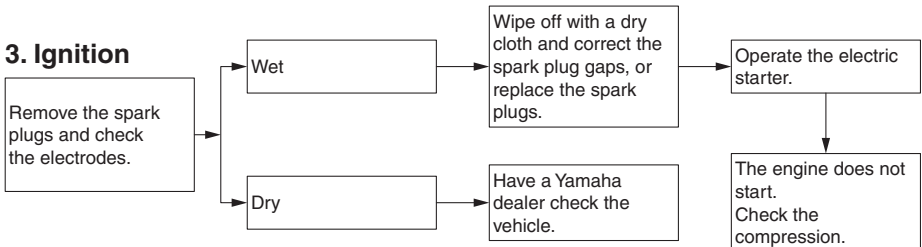

#### 4. Compression

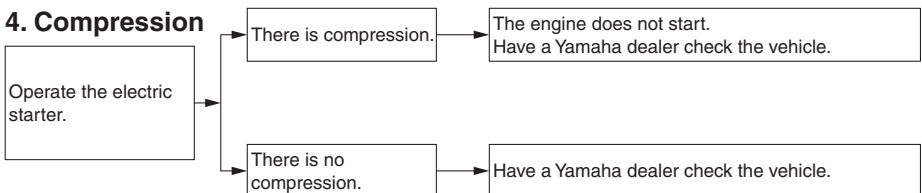

# Periodic maintenance and adjustment

## Engine overheating

EWAT1041

### **⚠ WARNING**

- Do not remove the radiator cap when the engine and radiator are hot. Scalding hot fluid and steam may be blown out under pressure, which could cause serious injury. Be sure to wait until the engine has cooled.
- Place a thick rag, like a towel, over the radiator cap, and then slowly rotate the cap counterclockwise to the detent to allow any residual pressure to escape. When the hissing sound has stopped, press down on the cap while turning it counterclockwise, and then remove the cap.

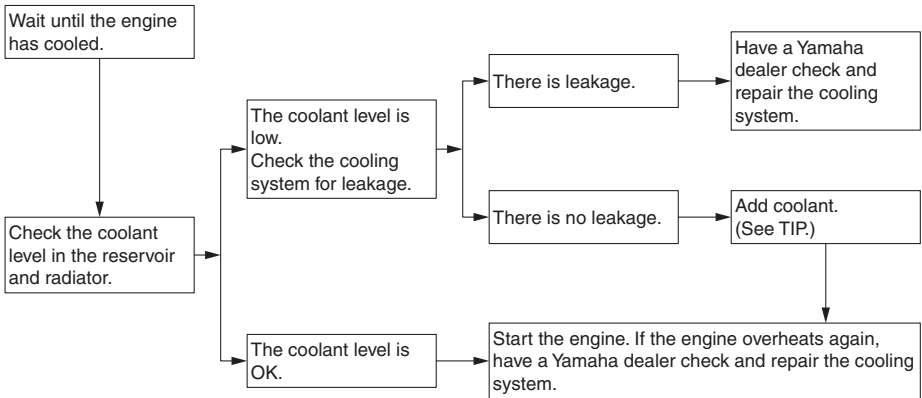

### **TIP**

If coolant is not available, tap water can be temporarily used instead, provided that it is changed to the recommended coolant as soon as possible.

## Matte color caution

EAU37834

EAU83443

### **NOTICE**

ECA15193

Some models are equipped with matte colored finished parts. Be sure to consult a Yamaha dealer for advice on what products to use before cleaning the vehicle. Using a brush, harsh chemical products or cleaning compounds when cleaning these parts will scratch or damage their surface. Wax also should not be applied to any matte colored finished parts.

## Care

Frequent, thorough cleaning of the vehicle will not only enhance its appearance but also will improve its general performance and extend the useful life of many components. Washing, cleaning, and polishing will also give you a chance to inspect the condition of the vehicle more frequently. Be sure to wash the vehicle after riding in the rain or near the sea, because salt is corrosive to metals.

### **TIP**

- The roads of heavy snowfall areas may be sprayed with salt as a de-icing method. This salt can stay on the roads well into spring, so be sure to wash the underside and chassis parts after riding in such areas.
- Genuine Yamaha care and maintenance products are sold under the YAMALUBE brand in many markets worldwide.
- See your Yamaha dealer for additional cleaning tips.

ECA26280

### **NOTICE**

Improper cleaning can cause cosmetic and mechanical damage. Do not use:

- high-pressure washers or steam-jet cleaners. Excessive water pressure may cause water seepage and deterioration of wheel bearings, brakes, transmission seals and electrical devices. Avoid high-pressure detergent applications such as those available in coin-operated car washers.

# Motorcycle care and storage

---

- harsh chemicals, including strong acidic wheel cleaners, especially on spoke or magnesium wheels.
- harsh chemicals, abrasive cleaning compounds, or wax on matte-finished parts. Brushes can scratch and damage the matte-finish, use soft sponge or towel only.
- towels, sponges, or brushes contaminated with abrasive cleaning products or strong chemicals such as, solvents, gasoline, rust removers, brake fluid, or antifreeze, etc.

---

## Before washing

1. Park the vehicle out of direct sunlight and allow it to cool. This will help avoid water spots.
2. Make sure all caps, covers, electrical couplers and connectors are tightly installed.
3. Cover the muffler end with a plastic bag and a strong rubber band.
4. Pre-soak stubborn stains like insects or bird droppings with a wet towel for a few minutes.
5. Remove road grime and oil stains with a quality degreasing agent and a plastic-bristle brush or sponge. **NOTICE: Do not use degreasing agent on areas requiring lubrication such as seals, gaskets, and wheel axles. Follow product instructions.**

[ECA26290]

## Washing

1. Rinse off any degreaser and spray down the vehicle with a garden hose. Use only enough pressure to do the job. Avoid spraying water directly into the muffler, instrument panel, air inlet, or other inner areas such as underseat storage compartments.
2. Wash the vehicle with a quality automotive-type detergent mixed with cool water and a soft, clean towel or sponge. Use an old toothbrush or plastic-bristle brush for hard-to-reach places. **NOTICE: Use cold water if the vehicle has been exposed to salt. Warm water will increase salt's corrosive properties.** [ECA26301]
3. For windshield-equipped vehicles: Clean the windshield with a soft towel or sponge dampened with water and a pH neutral detergent. If necessary, use a high-quality windshield cleaner or polish for motorcycles. **NOTICE: Never use any strong chemicals to clean the windshield. Additionally, some cleaning compounds for plastic may scratch the windshield, so be sure to test all cleaning products before general application.** [ECA26310]
4. Rinse off thoroughly with clean water. Be sure to remove all detergent residues, as they can be harmful to plastic parts.

## After washing

1. Dry the vehicle with a chamois or absorbent towel, preferably microfiber terrycloth.



# Motorcycle care and storage

ECA26320

2. For drive chain-equipped models: Dry and then lubricate the drive chain to prevent rust.
3. Use a chrome polish to shine chrome, aluminum, and stainless steel parts. Often the thermally induced discoloring of stainless steel exhaust systems can be removed through polishing.
4. Apply a corrosion protection spray on all metal parts including chrome or nickel-plated surfaces. **WARNING! Do not apply silicone or oil spray to seats, hand grips, rubber foot pegs or tire treads. Otherwise these parts will become slippery, which could cause loss of control. Thoroughly clean the surfaces of these parts before operating the vehicle.** [EWA20650]
5. Treat rubber, vinyl, and unpainted plastic parts with a suitable care product.
6. Touch up minor paint damage caused by stones, etc.
7. Wax all painted surfaces using a non-abrasive wax or use a detail spray for motorcycles.
8. When finished cleaning, start the engine and let it idle for several minutes to help dry any remaining moisture.
9. If the headlight lens has fogged up, start the engine and turn on the headlight to help remove the moisture.
10. Let the vehicle dry completely before storing or covering it.

## NOTICE

- Do not apply wax to rubber or unpainted plastic parts.
- Do not use abrasive polishing compounds as they will wear away the paint.
- Apply sprays and wax sparingly. Wipe off excess afterwards.

EWA20660

## WARNING

**Contaminants left on the brakes or tires can cause loss of control.**

- Make sure there is no lubricant or wax on the brakes or tires.
- If necessary, wash the tires with warm water and a mild detergent.
- If necessary, clean the brake discs and pads with brake cleaner or acetone.
- Before riding at higher speeds, test the vehicle's braking performance and cornering behavior.

# Motorcycle care and storage

---

EAU83472

## Storage

Always store the vehicle in a cool, dry place. If necessary, protect it against dust with a porous cover. Be sure the engine and the exhaust system are cool before covering the vehicle. If the vehicle often sits for weeks at a time between uses, the use of a quality fuel stabilizer is recommended after each fill-up.

ECA21170

### **NOTICE**

- **Storing the vehicle in a poorly ventilated room or covering it with a tarp, while it is still wet, will allow water and humidity to seep in and cause rust.**
- **To prevent corrosion, avoid damp cellars, stables (because of the presence of ammonia) and areas where strong chemicals are stored.**

8

## Long term storage

Before storing the vehicle long term (60 days or more):

1. Make all necessary repairs and perform any outstanding maintenance.
2. Follow all instructions in the Care section of this chapter.
3. Fill up the fuel tank, adding fuel stabilizer according to product instructions. Run the engine for 5 minutes to distribute treated fuel through the fuel system.
4. For vehicles equipped with a fuel cock: Turn the fuel cock lever to the off position.

5. For vehicles with a carburetor: To prevent fuel deposits from building up, drain the fuel in the carburetor float chamber into a clean container. Retighten the drain bolt and pour the fuel back into the fuel tank.
6. Use a quality engine fogging oil according to product instructions to protect internal engine components from corrosion. If engine fogging oil is not available, perform the following steps for each cylinder:
  - a. Remove the spark plug cap and spark plug.
  - b. Pour a teaspoonful of engine oil into the spark plug bore.
  - c. Install the spark plug cap onto the spark plug, and then place the spark plug on the cylinder head so that the electrodes are grounded. (This will limit sparking during the next step.)
  - d. Turn the engine over several times with the starter. (This will coat the cylinder wall with oil.)  
**WARNING! To prevent damage or injury from sparking, make sure to ground the spark plug electrodes while turning the engine over.**
7. Lubricate all control cables, pivots, levers and pedals, as well as the sidestand and centerstand (if equipped).

[EWA10952]

# Motorcycle care and storage

---

8. Check and correct the tire air pressure, and then lift the vehicle so that all wheels are off the ground. Otherwise, turn the wheels a little once a month in order to prevent the tires from becoming degraded in one spot.
9. Cover the muffler outlet with a plastic bag to prevent moisture from entering it.
10. Remove the battery and fully charge it, or attach a maintenance charger to keep the battery optimally charged. **NOTICE: Confirm that the battery and its charger are compatible. Do not charge a VRLA battery with a conventional charger.** [ECA26330]

## TIP

---

- If the battery will be removed, charge it once a month and store it in a temperate location between 0-30 °C (32-90 °F).
  - See page 7-33 for more information on charging and storing the battery.
-

# Specifications

## Dimensions:

- Overall length:  
2230 mm (87.8 in)
- Overall width:  
750 mm (29.5 in)
- Overall height:  
1325/1455 mm (52.2/57.3 in)
- Seat height:  
805/825 mm (31.7/32.5 in)
- Wheelbase:  
1545 mm (60.8 in)
- Ground clearance:  
125 mm (4.92 in)
- Minimum turning radius:  
3.2 m (10.50 ft)

## Weight:

- Curb weight:  
291 kg (642 lb)

## Engine:

- Combustion cycle:  
4-stroke
- Cooling system:  
Liquid cooled
- Valve train:  
DOHC
- Cylinder arrangement:  
Inline
- Number of cylinders:  
4-cylinder
- Displacement:  
1298 cm<sup>3</sup>
- Bore × stroke:  
79.0 × 66.2 mm (3.11 × 2.61 in)
- Starting system:  
Electric starter

## Engine oil:

- Recommended brand:



- SAE viscosity grades:  
10W-40, 10W-50, 15W-40, 20W-40 or  
20W-50

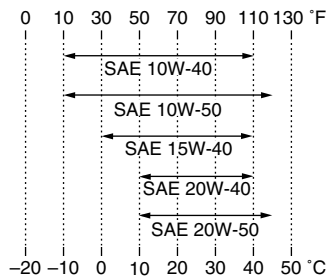

- Recommended engine oil grade:  
API service SG type or higher, JASO  
standard MA

## Engine oil quantity:

- Oil change:  
3.80 L (4.02 US qt, 3.34 Imp.qt)
- With oil filter removal:  
4.00 L (4.23 US qt, 3.52 Imp.qt)

## Final gear oil:

- Type:  
Yamaha genuine shaft drive gear oil SAE  
80W-90 API GL-5
- Quantity:  
0.20 L (0.21 US qt, 0.18 Imp.qt)

## Coolant quantity:

- Coolant reservoir (up to the maximum level  
mark):  
0.25 L (0.26 US qt, 0.22 Imp.qt)
- Radiator (including all routes):  
2.60 L (2.75 US qt, 2.29 Imp.qt)

## Fuel:

- Recommended fuel:  
Regular unleaded gasoline (Gasohol [E10]  
acceptable)
- Fuel tank capacity:  
25 L (6.6 US gal, 5.5 Imp.gal)
- Fuel reserve amount:  
5.5 L (1.45 US gal, 1.21 Imp.gal)

## Fuel injection:

- Throttle body:  
ID mark:  
1MC1 00

## Drivetrain:

- Gear ratio:  
1st:  
2.500 (35/14)
- 2nd:  
1.722 (31/18)

3rd:  
1.350 (27/20)  
4th:  
1.111 (30/27)  
5th:  
0.963 (26/27)  
6th:  
0.846 (22/26)

## Front tire:

Type:  
Tubeless  
Size:  
120/70ZR17M/C (58W)  
Manufacturer/model:  
BRIDGESTONE/BT023F E

## Rear tire:

Type:  
Tubeless  
Size:  
180/55ZR17M/C(73W)  
Manufacturer/model:  
BRIDGESTONE/BT023R E

## Loading:

Maximum load:  
213 kg (470 lb)  
(Total weight of rider, passenger, cargo and accessories)

## Unified brake system:

Operation:  
Activated by rear brake

## Front brake:

Type:  
Hydraulic dual disc brake

## Rear brake:

Type:  
Hydraulic single disc brake

## Front suspension:

Type:  
Telescopic fork

## Rear suspension:

Type:  
Swingarm (link suspension)

## Electrical system:

System voltage:  
12 V

## Battery:

Model:  
GT14B-4  
Voltage, capacity:  
12 V, 12.0 Ah (10 HR)

## Bulb wattage:

Headlight:  
LED  
Brake/tail light:  
LED  
Front turn signal/position light:  
LED  
Rear turn signal light:  
LED  
Auxiliary light:  
LED  
License plate light:  
LED

# Consumer information

EAU26357

EAU26401

## Identification numbers

Record the vehicle identification number, engine serial number, model label information, and the key identification number in the spaces provided below. These identification numbers are needed when registering the vehicle with the authorities in your area and when ordering spare parts from a Yamaha dealer.

VEHICLE IDENTIFICATION NUMBER:

ENGINE SERIAL NUMBER:

MODEL LABEL INFORMATION:

KEY IDENTIFICATION NUMBER:

## Vehicle identification number

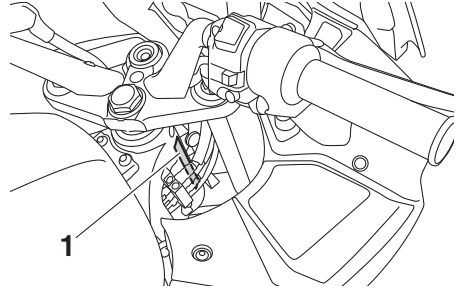

1. Vehicle identification number

The vehicle identification number is stamped into the steering head pipe. Record this number in the space provided.

### TIP \_\_\_\_\_

The vehicle identification number is used to identify your motorcycle and may be used to register your motorcycle with the licensing authority in your area.

## Engine serial number

EAU26442

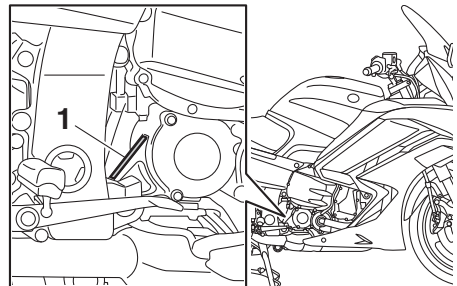

1. Engine serial number

The engine serial number is stamped into the crankcase.

## Model label

EAU26521

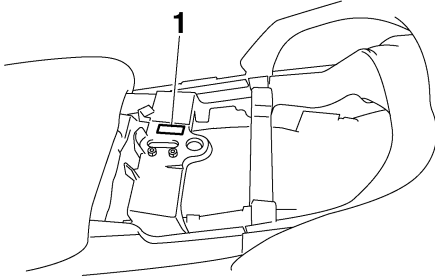

1. Model label

The model label is affixed to the frame under the passenger seat. (See page 4-31.) Record the information on this label in the space provided. This information will be needed when ordering spare parts from a Yamaha dealer.

## Vehicle Emission Control Information label

EAU48271

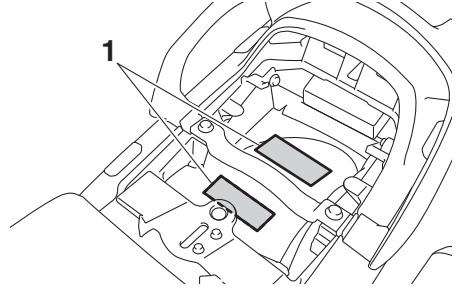

1. Vehicle Emission Control Information label

The Vehicle Emission Control Information label is affixed at the location in the illustration. This label shows specifications related to exhaust emissions as required by federal law, state law and Environment Canada.

## Key identification number

EAU26382

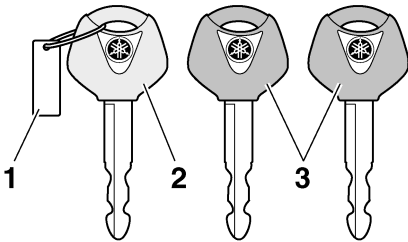

1. Key identification number
2. Code re-registering key (red bow)
3. Standard keys (black bow)

The key identification number is stamped into the key tag. Record this number in the space provided and use it for reference when ordering a new key.

## Diagnostic connector

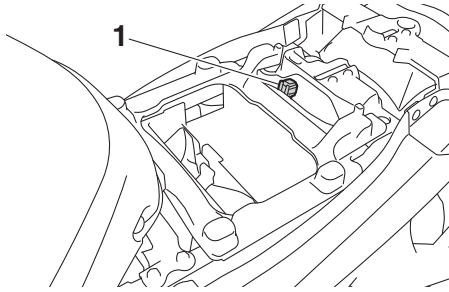

1. Diagnostic connector

The diagnostic connector is located as shown.

## Vehicle data recording

This model's ECU stores certain vehicle data to assist in the diagnosis of malfunctions and for research, statistical analysis and development purposes.

Although the sensors and recorded data will vary by model, the main data points are:

- Vehicle status and engine performance data
- Fuel-injection and emission-related data

This data will be uploaded only when a special Yamaha diagnostic tool is attached to the vehicle, such as when maintenance checks or service procedures are performed.

## Performance and Use of Your Yamaha Product

Yamaha products and connected device applications may collect, use, and share data related to your use of and the performance of your Yamaha Product. This data (if collected at all) is collected either through your use of connected device applications or through diagnostic tools and is used by Yamaha, its affiliates and servicers generally to provide more effective service and maintenance of your Yamaha product, as well as to continue to provide and improve quality products, features and services.

Yamaha will not disclose this data to a third party except in the following cases. In addition, Yamaha may provide vehicle data to a contractor in order to outsource services related to the handling of vehicle data. Even in this case,



Yamaha will require the contractor to properly handle the vehicle data we provided and Yamaha will appropriately manage the data.

- With the consent of the vehicle owner
- Where obligated by law
- For use by Yamaha in litigation
- When the data is not related to an individual vehicle nor owner

# Consumer information

---

EAU89660

## Reporting safety defects

If you believe that your vehicle has a defect which could cause a crash or could cause injury or death, you should immediately inform Transport Canada in addition to notifying Yamaha Motor Canada Ltd, Canada. If Transport Canada receives similar complaints, it may open an investigation, and if it finds that a safety defect exists in a group of vehicles, it may order a recall and remedy campaign. However, Transport Canada cannot become involved in individual problems between you, your dealer, or Yamaha Motor Canada Ltd., Canada.

To contact Transport Canada, you may call Defect Investigations and Recall Division at 819-994-3328 or toll free 1-800-333-0510, go to [www.tc.gc.ca](http://www.tc.gc.ca) or email: [mvs-sa@tc.gc.ca](mailto:mvs-sa@tc.gc.ca) or write to Transport Canada, 330 Sparks Street Ottawa, ON, K1A 0N5.

You can also obtain other information about motor vehicle safety from [www.tc.gc.ca](http://www.tc.gc.ca).

## Maintenance record

Copies of work orders and/or receipts for parts purchased and installed on your vehicle will be required to document that maintenance has been completed in accordance with the emissions warranty. The chart below is printed only as a reminder that maintenance work is required. It is not acceptable proof of maintenance work.

Maintenance interval	Date of service	Mileage	Servicing dealer name and address	Remarks
1000 km (600 mi) or 1 month				
7000 km (4000 mi) or 6 months				
13000 km (8000 mi) or 12 months				
19000 km (12000 mi) or 18 months				
25000 km (16000 mi) or 24 months				
31000 km (20000 mi) or 30 months				
37000 km (24000 mi) or 36 months				
43000 km (28000 mi) or 42 months				
49000 km (32000 mi) or 48 months				
55000 km (36000 mi) or 54 months				
61000 km (40000 mi) or 60 months				

## YAMAHA MOTOR CANADA LTD. MOTORCYCLE WARRANTY GUIDE

Congratulations on the purchase of your new Yamaha motorcycle. You have chosen a quality product designed and manufactured to bring you years of enjoyment.

This information explains Yamaha's warranty policy. You will find the answers to most of your questions by reading it through.

If you require further assistance, see your Yamaha dealer. Their qualified personnel will be pleased to meet all your service requirements, both during and after the warranty period.

Keep in mind that Yamaha manufactures many other quality products too. For further information on our complete line-up, contact your dealer or visit our web site.

For a product brochure, or a dealer near you, go to our web site.

Yamaha Motor Canada Ltd.

480 Gordon Baker Road, Toronto, Ontario M2H 3B4

(416) 498-1911

[www.yamaha-motor.ca](http://www.yamaha-motor.ca)

### Yamaha Motorcycle Warranty Policy

In this warranty, the term 'MOTORCYCLE' shall refer to a new motorcycle manufactured by YAMAHA MOTOR COMPANY, LTD. ('MANUFACTURER') under the trade name of Yamaha, distributed by YAMAHA MOTOR CANADA LTD. ('YAMAHA'), sold at retail by an authorized Yamaha dealer ('DEALER'). The term 'CUSTOMER' shall refer to the owner or lessee of record of the MOTORCYCLE registered with YAMAHA and to any subsequent owner, and the term 'DELIVERY' shall refer to the date of delivery of the MOTORCYCLE from the DEALER to the CUSTOMER.

### Section A — Warranty

Subject to Section D, YAMAHA offers the following warranty coverage to the CUSTOMER:

#### 1. Periods of warranty:

##### a) Pleasure Use (including government use)

###### i) Basic Period of Warranty

The period of warranty shall be ninety days commencing on DELIVERY on all models designated PW, TT and on YZ65 and YZ85 models.

The period of warranty shall be one year commencing on DELIVERY on all other models.

###### ii) Additional Period of Warranty for Street-Legal Motorcycles

In the event DELIVERY occurs between January 1<sup>st</sup> and April 30<sup>th</sup>, the warranty shall extend to April 30<sup>th</sup> of the following year.

##### b) Commercial Use

The period of warranty shall be half of the warranty period indicated for pleasure use, commencing on DELIVERY on any MOTORCYCLE which has been identified as being used for commercial applications.

#### 2. During these periods of warranty:

a) Any part defective by reason of the MANUFACTURER's faulty workmanship or material will be replaced or repaired free of charge.

b) Any repairs or adjustments made necessary by reason of the MANUFACTURER's faulty workmanship or material will be performed free of charge.

The MANUFACTURER reserves the right to change the design of any model without obligation to modify any model previously manufactured.

### Section B — Subsequent Owner

The warranty set forth in Section A may be transferred to any subsequent owner provided that the period of warranty has not expired and that the CUSTOMER has complied with all terms and conditions of this warranty.

The subsequent owner has the responsibility for ensuring that a change of registration is sent to YAMAHA at the time of such transfer of ownership.

This transfer MUST be done by contacting the DEALER who will forward the following information to YAMAHA:

1. the complete model and serial number as shown on the original warranty document;
2. the name of the previous owner;
3. the original delivery date of the MOTORCYCLE;
4. the complete name and address of the subsequent owner;
5. the indication that the subsequent owner has received and read the Owner's Manual and this warranty policy.

### Section C — Obtaining Repairs Under Warranty

To obtain repairs under warranty, the CUSTOMER must:

1. Ensure that the MOTORCYCLE is properly operated, maintained and stored as specified in the Owner's Manual.
2. Give notice to a DEALER of any and all apparent defects immediately upon discovery, and make the entire MOTORCYCLE available at that time for inspection and repair at the DEALER'S place of business.
3. Provide proof of warranty coverage to such DEALER (CUSTOMER'S copy of the New Vehicle Information Statement: N.V.I.S.).
4. Authorize the DEALER to tear down the MOTORCYCLE for diagnostic evaluation should it be required.

All warranty repairs must be done by a DEALER and final approval of any repairs rests with YAMAHA. All parts replaced become the property of YAMAHA.

### Section D — Exclusions

#### 1. This warranty does not apply unless:

a) The MOTORCYCLE has been fully assembled and set to the MANUFACTURER'S operating specifications by a DEALER prior to DELIVERY to the CUSTOMER.

b) The CUSTOMER has followed the break-in and storage instructions contained in the Owner's Manual and all other instructions shown in the Owner's Manual.

c) The CUSTOMER can provide record of maintenance having been performed as recommended in the Owner's Manual.

d) Requests for repairs under warranty have been made as prescribed in Section C.

#### 2. This warranty does not cover the repair of damage resulting from abuse or neglect of the MOTORCYCLE. Examples of abuse and neglect include, but are not limited to:

a) racing, competition, MOTORCYCLE models designated WR or YZ, with the exception of WR25R, WR25X, YZ65 and YZ85 models, modification of original parts or abnormal strain;

- b) use of lubricants, oils, fuel, fuel additives and mixtures other than those recommended in the Owner's Manual, improperly installed accessories or use of parts or accessories that are not equivalent in design and quality to genuine Yamaha parts;
  - c) damage as a result of accidents, collisions, contact with foreign materials, impact, submersion or use of the MOTORCYCLE after discovery of a defect;
  - d) appearance-related damages of body parts. Examples of such damages include but are not limited to: scratches, dents, fading, flaking, peeling.
3. This warranty does not extend to:
- a) MOTORCYCLES which have been modified in any way from the standard specifications as shown in the Owner's Manual, including any MOTORCYCLE whose odometer has been altered;
  - b) normal wear and tear, corrosion and routine maintenance, such as the recommended service inspections;
  - c) pre-delivery inspection and assembly;
  - d) MOTORCYCLES from which the MANUFACTURER's identification numbers have been removed or whose identification numbers have been altered or mutilated;
  - e) wear and tear and/or maintenance parts such as drive chains, clutch plates and facings, oils and lubricants, spark plugs, batteries, generator brushes, sealed beams and light bulbs, tires, filters, brake pads, drive belts and fuses;
  - f) inconvenience, loss of time, loss of income or loss of use of the MOTORCYCLE or any consequential damage of any kind;
  - g) damages from theft, fire, vandalism, explosion, water or acts of God;
  - h) storage costs, or transportation and shipping costs related to the performance of this warranty;
  - i) damage due to "flat towing" (see your DEALER for explanation).

## Section E — Emissions Control System Warranty (For applicable models only)

YAMAHA warrants to the CUSTOMER of a MOTORCYCLE covered by this warranty with a displacement of 50cc or greater, that the MOTORCYCLE is designed, built and equipped so as to conform at the time of DELIVERY with all federal emissions standards applicable at the time of manufacture and that it is free from defects in materials and workmanship which would cause it not to meet these standards within the periods listed immediately below. Failures other than those resulting from defects in material or workmanship, which arise solely as a result of owner abuse and/or lack of proper maintenance, are not covered by this warranty.

Engine Displacement	Period
50cc to 169cc	12,000 km or 5 years, whichever occurs first
170cc to 279cc	18,000 km or 5 years, whichever occurs first
280cc and over	30,000 km or 5 years, whichever occurs first

## Section F

This warranty is in addition to, and not a modification of, any warranty required by the laws of any province of Canada.

Subject to any applicable sales or consumer legislation, the above warranty is in lieu of any warranty or representation, expressed or implied, including any warranty of performance, merchantability or fitness for a particular purpose on the part of YAMAHA, and any other obligation or liability on behalf of YAMAHA, and the above warranty constitutes your sole remedy and the full liability of YAMAHA. In no event shall YAMAHA be liable for special, incidental or consequential damages howsoever caused, whether by negligence or otherwise resulting directly or indirectly from the use of the MOTORCYCLE, or the MOTORCYCLE having replacement parts or the unavailability of replacement parts.

YAMAHA does not assume, or authorize any person to create or assume for YAMAHA, any obligation or liability in connection with the MOTORCYCLE or any part thereof distributed by YAMAHA.

## Original Equipment Tires

Tires supplied as original equipment on your MOTORCYCLE are warranted separately by the individual tire manufacturer or its representatives. Generally speaking, this warranty covers defects in workmanship or material.

## Storing Your MOTORCYCLE

If your MOTORCYCLE is not to be used for 60 days or more, it must be properly stored to ensure against deterioration. You should consult your Owner's Manual for storage details, but WE RECOMMEND THAT YOU HAVE AN AUTHORIZED YAMAHA MOTORCYCLE DEALER PREPARE YOUR MOTORCYCLE FOR STORAGE. Their highly-trained staff have the experience and the qualifications to do the job right. YAMAHA cannot accept responsibility for damage to your vehicle or personal injury resulting from negligence or lack of experience in the preparation of your MOTORCYCLE for storage.

## Pre-delivery Inspection Checklist

The DEALER has assembled, inspected and tested the MOTORCYCLE according to the Yamaha Motorcycle Pre-delivery Inspection Checklist prior to DELIVERY to the CUSTOMER (some items may not be applicable to all models). These items include:

- Brakes
- Clutch
- Fluid Levels
- Drive System
- Cooling System
- Fuel / Throttle System
- Wheels / Tires / Suspension
- Steering and Controls
- Electrical System
- Replacing damaged or missing parts
- Test Ride

The Yamaha Motorcycle Pre-delivery Inspection Checklist has been provided to the CUSTOMER at the time of DELIVERY.

## Change of Address or Other Owner Information

If you should move after you have purchased your MOTORCYCLE, please contact the DEALER who will forward the required information to YAMAHA. Provide the DEALER with the model name and serial number as shown on the N.V.I.S., along with your new mailing address (or other information). This will ensure that YAMAHA has an up-to-date registration record.

# Index

- A**
  - ABS ..... 4-26
  - ABS warning light ..... 4-5
  - Accessory box ..... 4-36
  - Air filter element, cleaning ..... 7-17
  - Auxiliary DC jack ..... 4-44
- B**
  - Battery ..... 7-33
  - Brake and clutch fluid levels,
    - checking ..... 7-26
  - Brake and clutch fluids, changing ..... 7-27
  - Brake and clutch levers, checking and lubricating ..... 7-29
  - Brake and shift pedals, checking and lubricating ..... 7-29
  - Brake lever ..... 4-25
  - Brake lever free play, checking ..... 7-24
  - Brake light switches ..... 7-24
  - Brake pedal ..... 4-25
- C**
  - Cables, checking and lubricating ..... 7-28
  - Care ..... 8-1
  - Catalytic converters ..... 4-31
  - Centerstand and sidestand, checking and lubricating ..... 7-30
  - Clutch lever ..... 4-24, 7-23
  - Coolant ..... 7-16
  - Cornering lights ..... 4-48
  - Cowling vents, opening and closing ..... 4-38
  - Cruise control indicator lights ..... 4-4
  - Cruise control switches ..... 4-23
  - Cruise control system ..... 4-6
- D**
  - Data recording, vehicle ..... 10-3
  - Diagnostic connector ..... 10-3
  - Dimmer/Pass switch ..... 4-22
  - D-mode (drive mode) ..... 4-22
- E**
  - Engine break-in ..... 6-4
  - Engine idling speed, checking ..... 7-19
  - Engine oil and oil filter cartridge ..... 7-11
  - Engine serial number ..... 10-1
  - Engine trouble warning light ..... 4-4
- F**
  - Final gear oil ..... 7-14
  - Front and rear brake pads, checking ..... 7-25
  - Front fork, checking ..... 7-31
  - Fuel ..... 4-29
  - Fuel tank breather/overflow hose ..... 4-30
  - Fuel tank cap ..... 4-28
- Fuses, replacing** ..... 7-34
- H**
  - Handlebar position, adjusting ..... 4-37
  - Handlebar switches ..... 4-22
  - Hazard switch ..... 4-23
  - Headlight beams, adjusting ..... 4-37
  - High beam indicator light ..... 4-4
  - Horn switch ..... 4-23
- I**
  - Identification numbers ..... 10-1
  - Ignition circuit cut-off system ..... 4-46
  - Immobilizer system ..... 4-1
  - Immobilizer system indicator light ..... 4-5
  - Indicator lights and warning lights ..... 4-4
- K**
  - Key identification number ..... 10-2
- L**
  - Labels, location ..... 1-1
- M**
  - Main switch/steering lock ..... 4-2
  - Maintenance and lubrication, periodic ... 7-4
  - Maintenance, emission control system ..... 7-3
  - Maintenance record ..... 10-6
  - Matte color, caution ..... 8-1
  - Menu switch ..... 4-23
  - Model label ..... 10-2
  - Multi-function meter unit ..... 4-9
- N**
  - Neutral indicator light ..... 4-4
- O**
  - Oil level warning light ..... 4-4
- P**
  - Panels, removing and installing ..... 7-7
  - Parking ..... 6-5
  - Part locations ..... 3-1
- R**
  - Rear suspension, lubricating ..... 7-30
  - Rear view mirrors ..... 4-39
  - Rider seat height, adjusting ..... 4-33
- S**
  - Safety defects, reporting ..... 10-5
  - Safety information ..... 2-1
  - Seats ..... 4-31
  - Select switch ..... 4-23
  - Shifting ..... 6-3
  - Shift pedal ..... 4-24
  - Sidestand ..... 4-45
  - Spark plugs, checking ..... 7-10
  - Specifications ..... 9-1

Starting the engine .....	6-2
Steering, checking .....	7-32
Stop/Run/Start switch.....	4-23
Storage.....	8-4
Storage compartments .....	4-35
Suspension, adjusting the front and rear .....	4-40
Suspension system warning light .....	4-5
Swingarm pivots, lubricating.....	7-31

## T

Throttle grip and cable, checking and lubricating .....	7-28
Throttle grip free play, checking.....	7-19
Tires.....	7-20
Tool kit.....	7-2
Traction control system.....	4-27
Traction control system indicator light... ..	4-5
Troubleshooting .....	7-36
Troubleshooting charts .....	7-37
Turn signal indicator lights .....	4-4
Turn signal switch .....	4-23

## V

Valve clearance .....	7-20
Vehicle Emission Control Information label .....	10-2
Vehicle identification number .....	10-1
Vehicle lights .....	7-36

## W

Warranty.....	10-7
Wheel bearings, checking.....	7-32
Wheels.....	7-23

## Y

Yamalube .....	7-14
----------------	------





For your best ownership experience, think **Genuine Yamaha!**

**Genuine Yamaha Parts** – Genuine Yamaha replacement parts are the exact same parts as the ones originally equipped on your vehicle, providing you with the performance and durability you have come to expect. Why settle for aftermarket parts that may not provide full confidence and satisfaction?

**Genuine Yamaha Accessories** – Yamaha only offers accessories that meet our high standards for quality and performance. Buy with confidence, knowing your Genuine Yamaha Accessories will fit right and perform right – right out of the box.

**Yamalube** – Take care of your Yamaha with legendary Yamalube oils, lubricants, and care products. They're formulated and approved by the toughest judges we know: the Yamaha engineering teams that know your Yamaha from the inside out.

**Genuine Yamaha Service Manuals** – Get the same factory manual for your vehicle that the technicians at your authorized Yamaha dealer use. Service manuals are available through your Yamaha dealer or you can order them directly through [yamahapubs.com](http://yamahapubs.com) (for US consumers only).

Genuine Yamaha products are available only from your Yamaha dealer.

Find out more at:

For US consumers, please visit [yamaha-motor.com](http://yamaha-motor.com)

For Canadian consumers, please visit [yamaha-motor.ca](http://yamaha-motor.ca)



PRINTED IN JAPAN  
2020.10-0.3×1 CR (E)